



Delta Electronics, Inc.

Taoyuan1
31-1, Xingbang Road, Guishan Industrial Zone,
Taoyuan County 33370, Taiwan, R.O.C.
TEL: 886-3-362-6301 / FAX: 886-3-362-7267

Delta Electronics (Jiang Su) Ltd.

Wujiang Plant3
1688 Jiangxing East Road,
Wujiang Economic Development Zone,
Wujiang City, Jiang Su Province,
People's Republic of China (Post code: 215200)
TEL: 86-512-6340-3008 / FAX: 86-512-6340-7290

Delta Greentech (China) Co., Ltd.

238 Min-Xia Road, Cao-Lu Industry Zone, Pudong, Shanghai,
People's Republic of China
Post code : 201209
TEL 021-58635678 FAX 021-58630003

Delta Electronics (Japan), Inc.

Tokyo Office
Delta Building, 2-1-14
Shinjodaimon, Minato-Ku, Tokyo, 105-0012,
Japan
TEL: 81-3-5733-1111 / FAX: 81-3-5733-1211

Delta Electronics (Korea), Inc.

234-9, Duck Soo Building 7F, Nonhyun-Dong,
Kangnam-Gu, Seoul, Korea 135-010
TEL: 82-2-515-5305 / FAX: 82-2-515-5302

Delta Electronics Int'l (Singapore) Pte Ltd

4 Kaki Bukit Ave 1, # 05 - 05, Singapore 417939
TEL: 65-6747-5155 / FAX: 65-6744-9228

Delta Electronics (India) Pvt. Ltd.

Plot No. 43, Sector - 35, HSIIDC,
Gurgaon122001, Haryana, India
TEL: 91-124-416-9040 / FAX: 91-124-403-6045

Americas

Delta Products Corporation (USA)

Raleigh Office
P.O. Box 12173, 5101 Davis Drive,
Research Triangle Park, NC 27709, U.S.A.
TEL: 1-919-767-3813 / FAX: 1-919-767-3969

Delta Greentech (Brasil) S/A

Sao Paulo Office
Rua Itapeva, Nº 26, 3º andar, Bela vista
ZIP: 01332-000 - São Paulo - SP - Brasil
TEL: 55-11-3568-3875 / FAX: 55-11-3568-3865

Europe

Deltronics (The Netherlands) B.V

Eindhoven Office
De Witbogt 15, 5652 AG Eindhoven, The Netherlands
TEL: 31-40-2592850 / FAX: 31-40-2592851

*We reserve the right to change the information in this catalogue without prior notice



Delta Door Drives and Motors

VFD DD

User Manual

Delta presents you with an ideal drive for door applications



Preface

Firmware Version 1.07

Thank you for choosing DELTA's high-performance VFD-DD Series. The VFD-DD Series is manufactured with high-quality components and materials and incorporate the latest microprocessor technology available.

This manual is to be used for the installation, parameter setting, troubleshooting, and daily maintenance of the AC motor drive. To guarantee safe operation of the equipment, read the following safety guidelines before connecting power to the AC motor drive. Keep this operating manual at hand and distribute to all users for reference.

To ensure the safety of operators and equipment, only qualified personnel familiar with AC motor drive are to do installation, start-up and maintenance. Always read this manual thoroughly before using VFD-DD series AC Motor Drive, especially the WARNING, DANGER and CAUTION notes. Failure to comply may result in personal injury and equipment damage. If you have any questions, please contact your dealer.

PLEASE READ PRIOR TO INSTALLATION FOR SAFETY.



- ☑ AC input power must be disconnected before any wiring to the AC motor drive is made.
- ☑ A charge may still remain in the DC-link capacitors with hazardous voltages, when the power is turned off. Before opening the AC motor drive, ensure that power LED is off and use a multimeter to measure the voltage between L1 and L2, make sure it reaches a safe voltage level lower than 25Vdc.
- ☑ There are highly sensitive CMOS IC components on the printed circuit boards. These components are especially sensitive to static electricity. To prevent damage to these components, do not touch these components or the circuit boards with metal objects or your bare hands.
- ☑ Ground the VFD-DD drive using the ground terminal. The grounding method must comply with the local standard of the country which the drive is installed.
- ☑ VFD-DD series can only be used for variable speed control of 3-phase induction motors, it should NOT be applied to 1-phase motors or other purpose.
- ☑ VFD-DD series is a specific drive for elevator door and other automatic door control. It should not be installed in a location that may cause personal injury.
- ☑ To prevent personal injury, please keep children and unqualified people away from the equipments.



- ☑ Do NOT connect AC main power directly to the drive's output terminals U/T1, V/T2 and W/T3.
- ☑ DO NOT use Hi-pot test for internal components. The semi-conductor used in the AC motor drive is easily damaged by high-pressure.
- ☑ A charge may still remain in the main circuit terminals with hazardous voltages, even when motor has come to stop.
- ☑ Only the qualified technicians are allowed to install, wire and maintain AC motor drive.
- ☑ Be aware of the motor that it may rotate as soon as the RUN key is pressed using an external digital keypad, DO NOT stand next to the motor.



- ☑ DO NOT install the AC motor drive in a place subjected to high temperature, direct sunlight, high humidity, excessive vibration, corrosive gases or liquids, or airborne dust or metallic particles.
- ☑ Please regard the specification for AC motor drive installation. Failure to comply may result in fire, explosion or electric shock.
- ☑ When the motor cable between the AC motor drive and motor is too long, the layer insulation of the motor may be damaged. Please use a frequency inverter duty motor or add an AC output reactor to prevent damage to the motor.
- ☑ The rated voltage for the AC motor drive must be $\leq 240V$ and the mains supply current capacity must be $\leq 5000A$ RMS.



- Some of the graphics shown in this manual are the inner part of the drive after the cover is removed, when VFD-DD is in operation status, please make sure the cover and wiring are in the specified space as the manual indicates for personal safety.
- The drive customers received may be slightly different than the figures shown in the manual, this condition is normal and will cause no influences to the customer rights.
- Delta is always improving our products for greater efficiency; the content of this document may be modified or changed without prior notice. Please contact your local distributors or visit our website to download the most updated version at <http://www.delta.com.tw/industrialautomation/>.
- The AC motor drive may also be called as "drive", all drive mentioned in this manual refers to the AC motor drive.

Table of Content

Chapter 1 Introduction

1-1 Receiving and Inspection	1 - 2
1-2 Preparation for Installation and Wiring	1 - 4
1-3 Dimensions	1 - 6

Chapter 2 Wiring

2-1 Wiring Diagram	2 - 2
2-2 Main Circuit Terminal	2 - 5
2-3 Control Circuit Terminal.....	2 - 6

Chapter 3 Keypad and Start-up

3-1 Operation Method	3 - 2
3-2 Keypad Descriptions	3 - 3

Chapter 4 Parameter Settings

4-1 Summary of Parameter Settings	4 - 2
Group 00: System Parameters	4 - 2
Group 01: Motor Parameters.....	4 - 4
Group 02 : Input/Output Parameters	4 - 6
Group 03: Feedback Parameters	4 - 8
Group 04: Door Open Parameters	4 - 9
Group 05: Door Close Parameter.....	4 -10
Group 06: Protection and Special Parameters.....	4 -12
Group 07: Control Parameters	4 -15
Group 08: Multi-step Speed Parameters	4 -16
Group 09: Communication Parameters	4 -17
Group 10:User-defined Parameters	4 -18
Group 11:View User-defined Parameters	4 -20
4-2 Summary of Detailed Parameter Settings	4 -21
Group 00: System Parameters	4 -21
Group 01: Motor Parameters.....	4 -27
Group 02 : Input/Output Parameters	4 -34
Group 03: Feedback Parameters	4 -39

Group 04: Door Open Parameters.....	4 -42
Group 05: Door Close Parameter	4 -46
Group 06: Protection and Special Parameters.....	4 -51
Group 07: Control Parameters.....	4 -57
Group 08: Multi-step Speed Parameters.....	4 -60
Group 09: Communication Parameters	4 -61
Group 10: User-defined Parameters.....	4 -70
Group 11: View User-defined Parameters	4 -75

Chapter 5 Troubleshooting

5-1 Over Current (OC).....	5 - 2
5-2 Ground Fault (GFF).....	5 - 3
5-3 Over Voltage (OV).....	5 - 4
5-4 Low Voltage (Lv).....	5 - 5
5-5 Over Heat (OH1).....	5 - 6
5-6 Overload (OL)	5 - 7
5-7 Digital Display is Abnormal	5 - 8
5-8 Phase Loss (PHL)	5 - 9
5-9 Motor does not Run.....	5 - 10
5-10 Fail to Adjust Motor Speed.....	5 - 11
5-11 Motor Stalls During Acceleration	5 - 12
5-12 Motor Run Error.....	5 - 13
5-13 Electromagnetic/Induction Noise	5 - 14
5-14 Environmental Condition	5 - 15
5-15 Prevent Interference to other Devices	5 - 16

Chapter 6 Fault Codes and Descriptions

6-1 Common Problems and Solutions	6 - 2
6-2 Maintenance and Inspectations	6 - 7

Appendix A Specifications	A -1
---------------------------------	------

Appendix B How to Select an AC Motor Drive	B -1
--	------

B-1 Capacity Calculation	B - 2
B-2 General Precautions	B - 4
B-3 How to Choose a Suitable Motor.....	B - 5

Chapter 1 Introduction

1-1 Receiving and Inspection

1-2 Preparation for Installation and Wiring

1-3 Dimensions

The AC motor drive should be kept in the shipping carton or crate before installation. In order to retain the warranty coverage, the AC motor drive should be stored properly when it is not to be used for an extended period of time. Storage conditions are:



- ☑ Store in a clean and dry location free from direct sunlight or corrosive fumes.
- ☑ Store within an ambient temperature range of -20 °C to +60 °C.
- ☑ Store within a relative humidity range of 0% to 90% and non-condensing environment.
- ☑ Store within an air pressure range of 86 kPA to 106kPA.
- ☑ DO NOT place on the ground directly. It should be stored properly. Moreover, if the surrounding environment is humid, you should put exsiccator in the package.
- ☑ DO NOT store in an area with rapid changes in temperature. It may cause condensation and frost.
- ☑ If the AC motor drive is stored for more than 3 months, the temperature should not be higher than 30 °C. Storage longer than one year is not recommended, it could result in the degradation of the electrolytic capacitors.
- ☑ When the AC motor drive is not used for longer time after installation on building sites or places with humidity and dust, it's best to move the AC motor drive to an environment as stated above.

1-1 Receiving and Inspection

This VFD-VL AC motor drive has gone through rigorous quality control tests at the factory before shipment. After receiving the AC motor drive, please check for the following:

- ☑ Check to make sure that the package includes an AC motor drive, the User Manual/Quick Start and CD.
- ☑ Inspect the unit to assure it was not damaged during shipment.
- ☑ Make sure that the part number indicated on the nameplate corresponds with the part number of your order.

If the nameplate information does not match with your purchase order or if there are any other problems, please contact your local distributor immediately.

Nameplate Information

Example for 0.2kW/0.25HP 230V 1-Phase AC motor drive

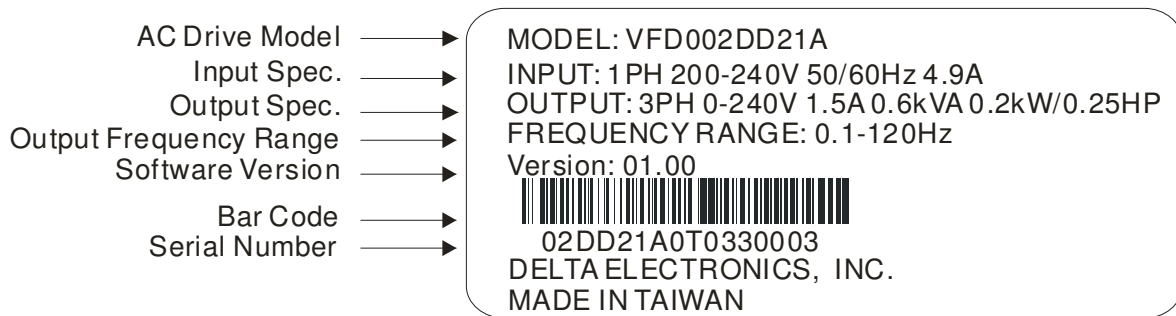

Explanation for Model

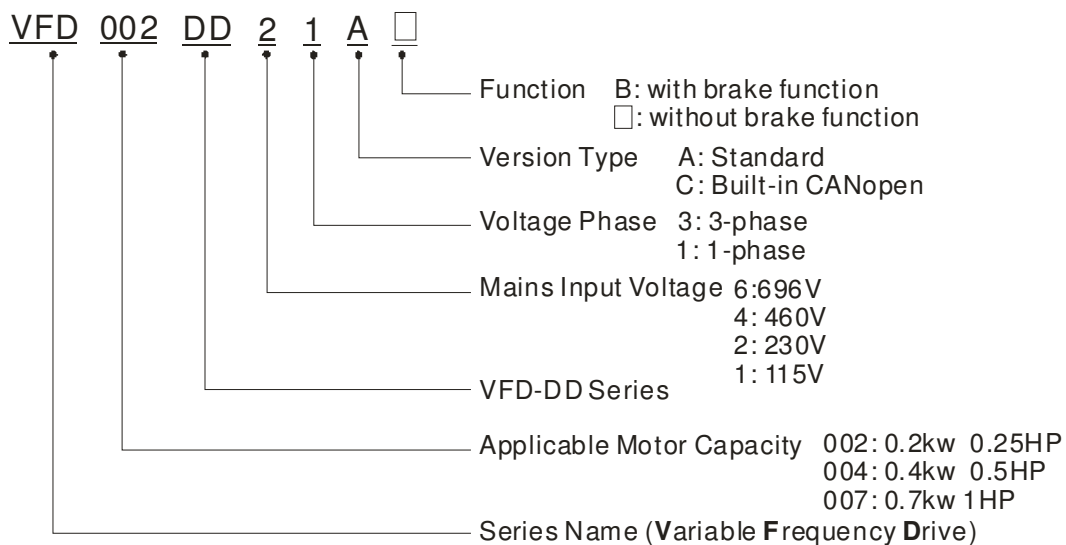

Explanation for Series Number

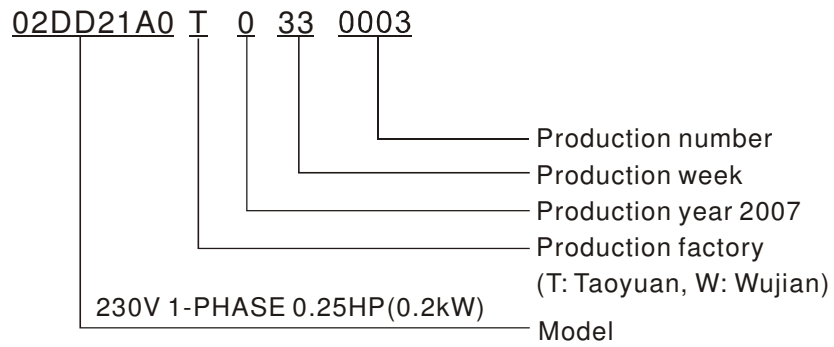

1-2 Preparation for Installation and Wiring

Install the AC motor drive in an environment with the following conditions:

Operation	Air Temperature:	-10 ~ +45 °C (14 ~ 113 °F)
	Relative Humidity:	<90%, no condensation allowed
	Atmosphere pressure:	86 ~ 106 kPa
	Installation Site Altitude:	<1000m
	Vibration:	<20Hz: 9.80 m/s ² (1G) max 20 ~ 50Hz: 5.88 m/s ² (0.6G) max
Storage Transportation	Temperature:	-20 °C ~ +60 °C (-4 °F ~ 140 °F)
	Relative Humidity:	<90%, no condensation allowed
	Atmosphere pressure:	86 ~ 106 kPa
	Vibration:	<20Hz: 9.80 m/s ² (1G) max 20 ~ 50Hz: 5.88 m/s ² (0.6G) max
Pollution Degree	2: can be used in a factory type environment.	

Minimum Mounting Clearances

- ☑ The drive installation can be on a platform or on the wall. The left and middle figures show the drive installation on a platform from the front and the side-view. The right figure shows wall mounting. Both platform mounting and wall mounting are required to keep minimum mounting clearances for good ventilation.

A	B	C	D
20mm	15mm	20mm	8mm

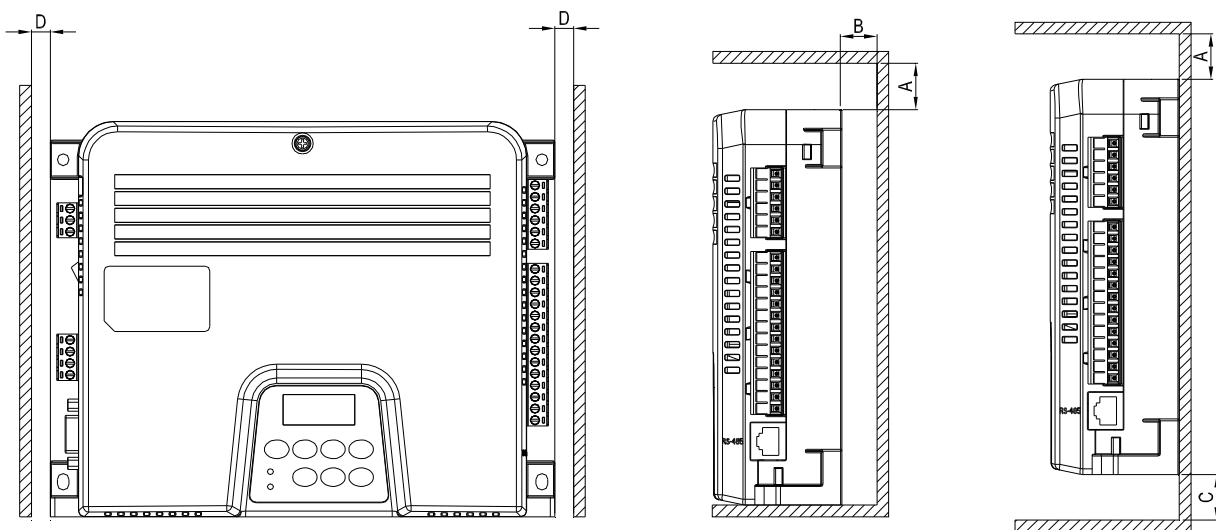

**CAUTION!**

1. Mount the AC motor drive vertically on a flat vertical surface by using bolts or screws. Other directions are not allowed.
2. The AC motor drive will generate heat during operation. Allow sufficient space around the unit for heat dissipation. When the AC motor drive is installed in a confined space (e.g. cabinet), the surrounding temperature must be with good ventilation. DO NOT install the AC motor drive in a space with bad ventilation.
3. The heat sink temperature may rise to 90°C when running. The material on which the AC motor drive is mounted must be noncombustible and be able to withstand this high temperature.
4. When installing multiple AC motor drives in the same cabinet, they should be adjacent in a row with enough space in-between. When installing one AC motor drive below another one, use a metal separation barrier between the AC motor drives to prevent mutual heating.

**NOTE**

Prevent fiber particles, scraps of paper, saw dust, metal particles, etc. from adhering to the heatsink. It is strongly recommend mounting the AC motor drive to inflammable materials such as metal for fire prevention.

1-3 Dimensions

VFD002DD21A; VFD002DDDD21AB; VFD002DD21C; VFD002DD21CB; VFD004DD21A;
VFD004DD21AB; VFD004DD21C; VFD004DD21CB

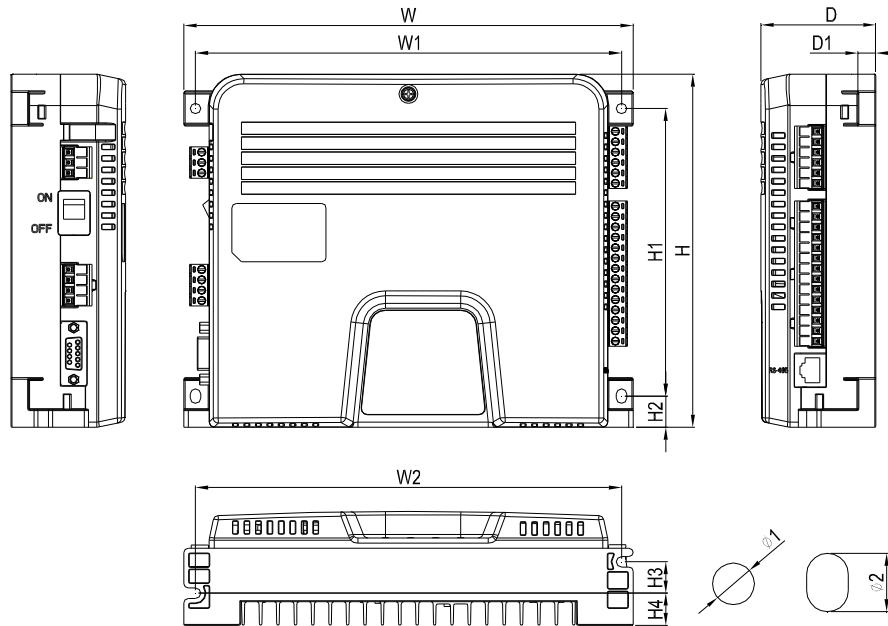

Unit: mm [inch]

W	W1	W2	H	H1	H2	H3	H4	D	D1	Φ1	Φ2
215.0	204.0	204.0	170.0	138.5	15.0	15.1	15.5	55.0	8.5	5.0	7.0
[8.46]	[8.03]	[8.03]	[6.69]	[5.45]	[0.59]	[0.59]	[0.61]	[2.17]	[0.34]	[0.20]	[0.28]

Dimensions for Motor

ECMD-B9120GMS

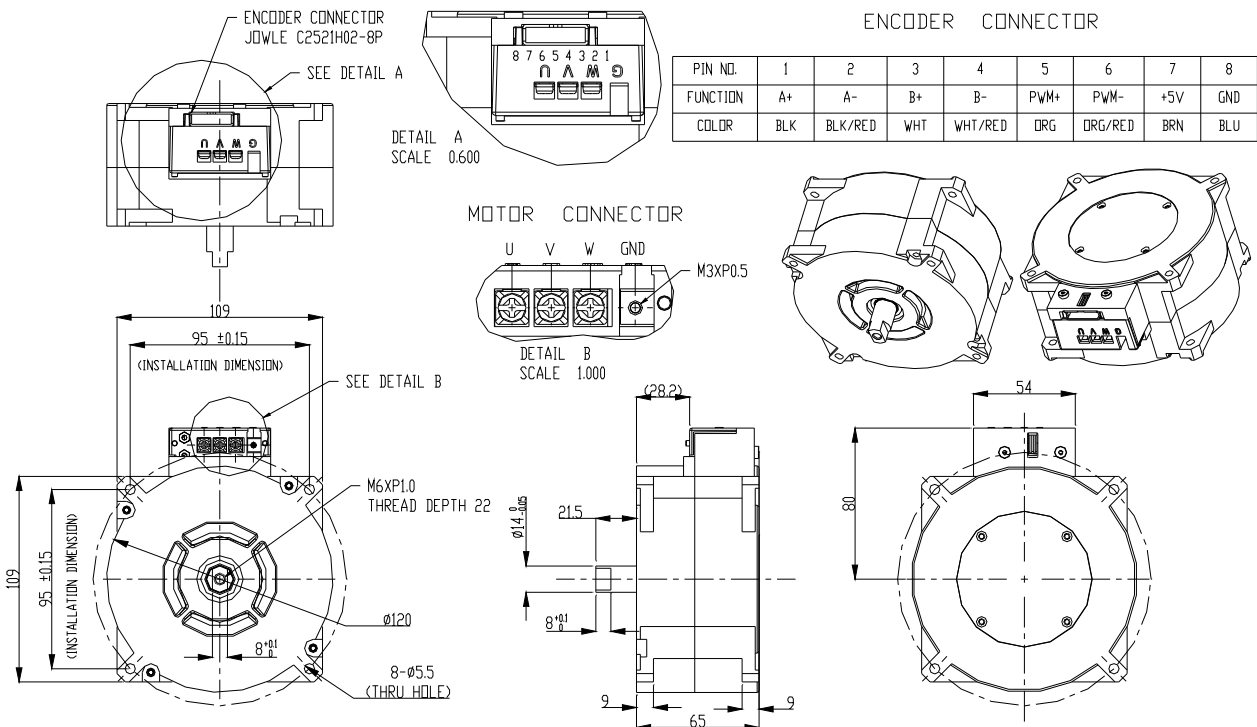

ECMD-B9160GMS

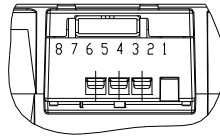
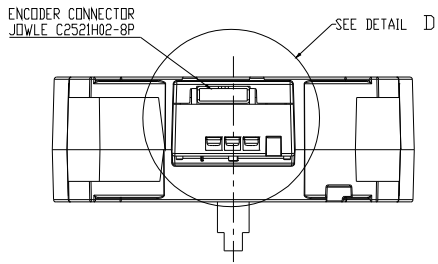

ENCODER CONNECTOR

PIN NO.	1	2	3	4	5	6	7	8
FUNCTION	A+	A-	B+	B-	PWM+	PWM-	+5V	GND

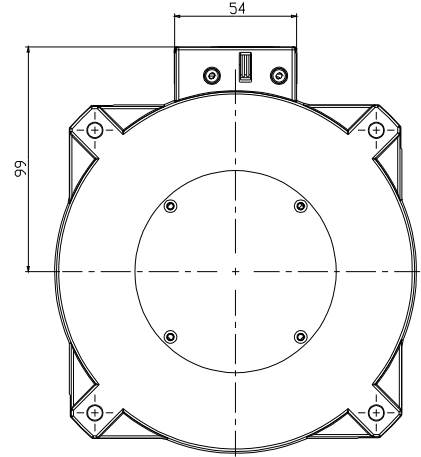
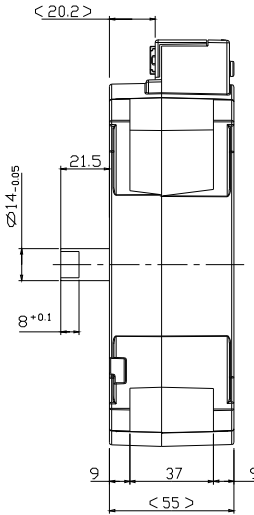
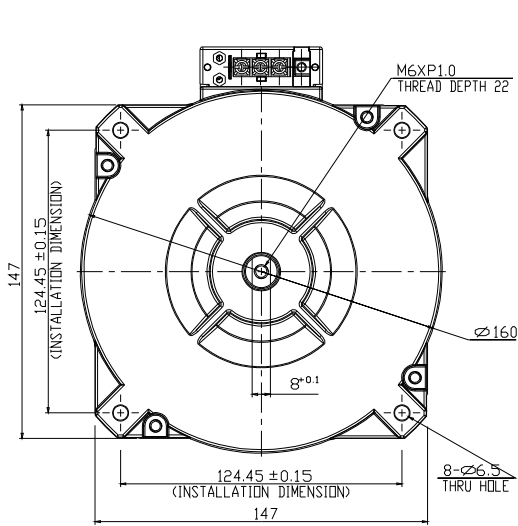
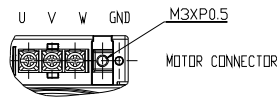

Chapter 2 Wiring

2-1 Wiring Diagram

2-2 Main Circuit Terminals

2-3 Control Circuit Terminals

After removing the front cover, examine if the power and control terminals are clearly noted. Please read following precautions before wiring.

- ☑ Make sure that power is only applied to the R/L1, S/L2, T/L3 terminals. Failure to comply may result in damage to the equipments. The voltage and current should lie within the range as indicated on the nameplate (Chapter 1-1).
- ☑ All the units must be grounded directly to a common ground terminal to prevent lightning strike or electric shock.
- ☑ Please make sure to fasten the screw of the main circuit terminals to prevent sparks which is made by the loose screws due to vibration



- ☑ It is crucial to turn off the AC motor drive power before any wiring installation is made. A charge may still remain in the DC bus capacitors with hazardous voltages even if the power has been turned off therefore it is suggested for users to measure the remaining voltage before wiring. For your personnel safety, please do not perform any wiring before the voltage drops to a safe level < 25 Vdc. Wiring installation with remaining voltage condition may cause sparks and short circuit.
- ☑ Only qualified personnel familiar with AC motor drives is allowed to perform installation, wiring and commissioning. Make sure the power is turned off before wiring to prevent electric shock.



- ☑ When wiring, please choose the wires with specification that complies with local regulation for your personnel safety.
- ☑ Check following items after finishing the wiring:
 1. Are all connections correct?
 2. No loose wires?
 3. No short-circuits between terminals or to ground?

2-1 Wiring Diagram

When wiring for an AC motor drive, user needs to connect wires to two sections, main circuit and control circuit. Please properly connect wires to your AC motor drive according to the circuit diagram provide in the following pages

VFD-DD Basic Wiring Diagram

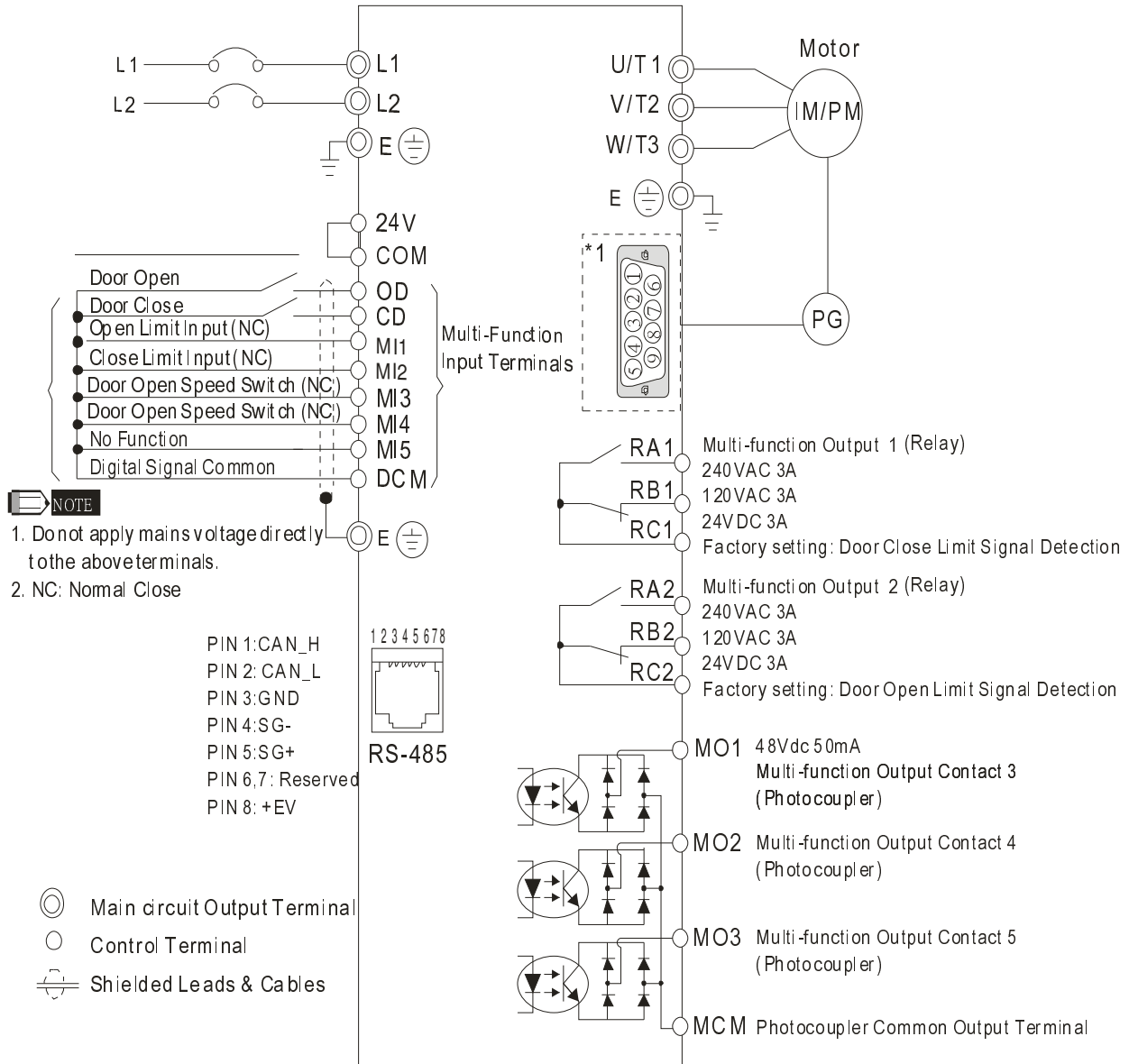

Wiring/Terminals Setting

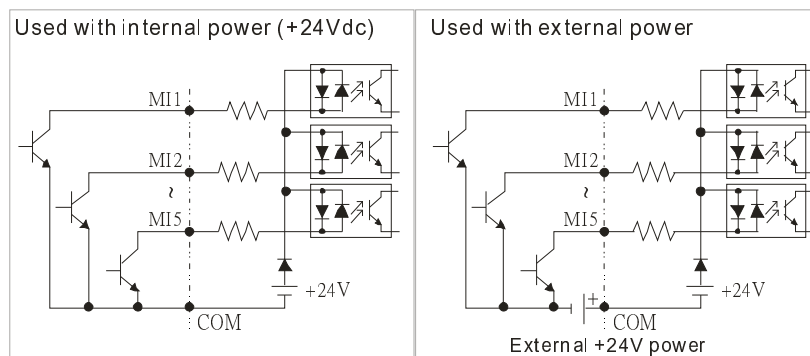

*1

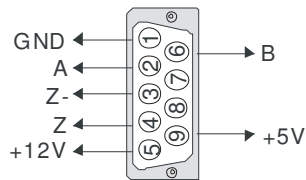

Induction motor: A, B, +5V, GND

Permanent magnet motor: A, B, Z, Z-, +5V, GND

CAUTION!

- ☑ The wiring of main circuit and control circuit should be separated to prevent erroneous actions.
- ☑ Please use shield wire for the control wiring and not to expose the peeled-off net in front of the terminal.
- ☑ Please use the shield wire or tube for the power wiring and ground the two ends of the shield wire or tube.
- ☑ Damaged insulation of wiring may cause personal injury or damage to circuits/equipment if it comes in contact with high voltage.
- ☑ The AC motor drive, motor and wiring may cause interference. To prevent the equipment damage, please take care of the erroneous actions of the surrounding sensors and the equipment.
- ☑ When the AC drive output terminals U/T1, V/T2, and W/T3 are connected to the motor terminals U/T1, V/T2, and W/T3, respectively. To permanently reverse the direction of motor rotation, switch over any of the two motor leads.
- ☑ With long motor cables, high capacitive switching current peaks can cause over-current, high leakage current or lower current readout accuracy. For usage of long motor cables use an AC output reactor.
- ☑ The AC motor drive, electric welding machine and the greater horsepower motor should be grounded separately.
- ☑ Use ground leads that comply with local regulations and keep them as short as possible.
- ☑ No braking resistor is built in the VFD-M-D series, it can install braking resistor for those occasions that use higher load inertia or frequent start/stop. Refer to Appendix B for details.
- ☑ Multiple VFD-M-D units can be installed in one location. All the units should be grounded directly to a common ground terminal, as shown in the figure below. Ensure there are no ground loops.



- ☑ The wiring of main circuit and control circuit should be separated to prevent erroneous actions.
- ☑ Please use shield wire for the control wiring and not to expose the peeled-off net in front of the terminal.
- ☑ Please use the shield wire or tube for the power wiring and ground the two ends of the shield wire or tube.
- ☑ Damaged insulation of wiring may cause personal injury or damage to circuits/equipment if it comes in contact with high voltage.
- ☑ The AC motor drive, motor and wiring may cause interference. To prevent the equipment damage, please take care of the erroneous actions of the surrounding sensors and the equipment.
- ☑ The AC drive output terminals U/T1, V/T2, and W/T3 should connect to the

motor terminals U/T1, V/T2, and W/T3 respectively. To reverse the direction of motor rotation, please switch over any of the two motor leads.

- ☑ With long motor cables, high capacitive switching current peaks can cause over-current, high leakage current or lower current readout accuracy. For longer motor cables use an AC output reactor.
- ☑ The AC motor drive, electric welding machine and the greater horsepower motor should be grounded separately.
- ☑ Use ground leads that comply with local regulations and keep them as short as possible.
- ☑ Use ground leads that comply with local regulations and keep them as short as possible.
- ☑ Multiple AC drives can be installed in one location. All the units should be grounded directly to a common ground terminal, as shown in the figure below.

Ensure there are no ground loops.

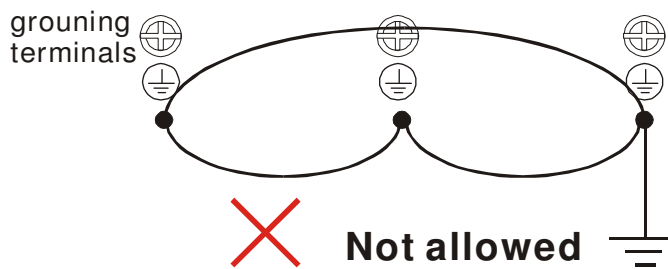
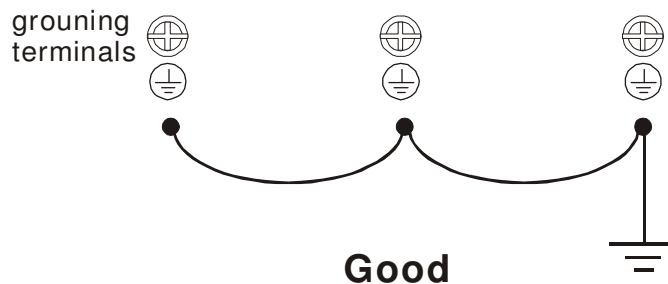
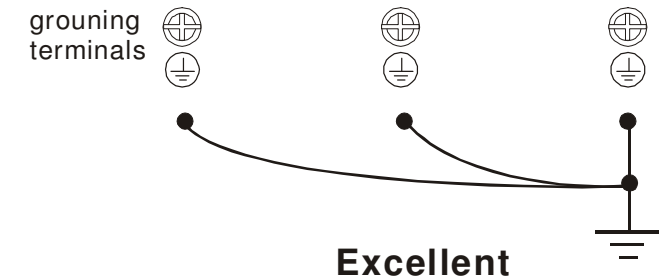

2-2 Main Circuit Terminals

Main Circuit Terminals

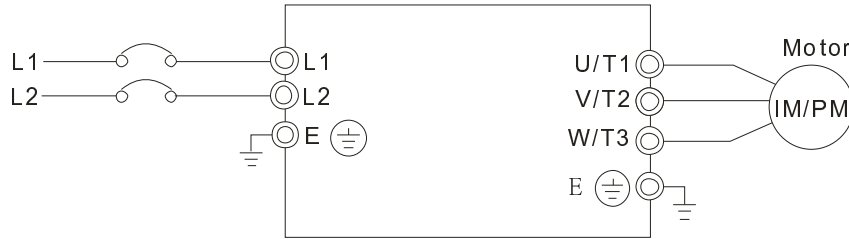

Wire Gauge	Torque	Wire Type
14-12 AWG. (2.075-3.332mm ²)	5.2kgf-cm (4.5in-lbf)	Stranded copper only , 75°C

Terminal Symbol	Explanation of Terminal Functions
L1, L2	AC line input terminals
U/T1, V/T2, W/T3	AC drive output terminals for connecting 3-phase induction motor
⊕ E	Earth connection, please comply with local regulations.



Mains power terminals

- ☑ Power can be connected to either L1 or L2.
- ☑ On the main circuit terminals, fasten all screws to prevent sparks which is made by the loose screws due to vibration
- ☑ Please use voltage and current within the regulation shown in Appendix A.
- ☑ For the AC motor drive built-in with a general type of GFCI (Ground Fault Circuit Interrupter), it is suggested to select a current sensor with sensitivity of 200mA, and not less than 0.1-second detection time to avoid nuisance tripping. When selecting a GFCI that is specially designed for an AC motor drive, please select the current sensor with sensitivity of 30mA or above.
- ☑ Please use the shield wire or tube for the power wiring and ground the two ends of the shield wire or tube.
- ☑ Do NOT run/stop AC motor drives by turning the power ON/OFF. Run/stop AC motor drives by RUN/STOP command via control terminals or keypad. If you still need to run/stop AC drives by turning power ON/OFF, it is recommended to do so only ONCE per hour.

Main circuit output terminals

- ☑ When it needs to install the filter at the output side of terminals U/T1, V/T2, W/T3 on the AC motor drive. Please use inductance filter. Do not use phase-compensation capacitors or L-C (Inductance-Capacitance) or R-C (Resistance-Capacitance), unless approved by Delta.
- ☑ DO NOT connect phase-compensation capacitors or surge absorbers at the output terminals of AC motor drives.
- ☑ Use a well-insulated motor, suitable for inverter operation.

2-3 Control Circuit Terminals



Torque	Wire Gauge
5 kgf-cm (6.9 in-lbf)	18-12 AWG (0.8107-3.332mm ²)

Terminal Symbol	Terminal Function	Factory Setting (NPN Mode)
OD	Door Open to Stop	OD-DCM: ON: Open ; OFF: Decelerate to stop
CD	Door Close to Stop	CD-DCM: ON: Close; OFF: Decelerate to stop
MI1	Multi-function Input 1	Refer to Pr. 02-01~02-05 for programming of Multi-function Inputs 1~5. ON: the input voltage is 24Vdc(Max: 30Vdc), input impedance is 3.75kΩ OFF: leakage current tolerance is 10μA.
MI2	Multi-function Input 2	
MI3	Multi-function Input 3	
MI4	Multi-function Input 4	
MI5	Multi-function Input 5	
COM	Digital control signal common	Common for digital inputs
+E24V	Digital Signal Common	+24V 80mA
DCM	Digital Signal Common	Common for digital inputs
RA1	Multi-function Relay1 output (N.O.) a	Resistive Load: 5A(N.O.)/3A(N.C.) 240VAC 5A(N.O.)/3A(N.C.) 24VDC Inductive Load: 1.5A(N.O.)/0.5A(N.C.) 240VAC 1.5A(N.O.)/0.5A(N.C.) 24VDC
RB1	Multi-function Relay1 output (N.C.) b	
RC1	Multi-function Relay1 common	
RA2	Multi-function Relay2 output (N.O.) a	To output any monitoring signal including in operation , frequency attained, overload indicator...etc, please refer to Pr.02-08~02-12 for MO selection.
RB2	Multi-function Relay2 common	
RC2	Multi-function Output 1 (Photocoupler)	
MO1	Multi-function Output 1 (Photocoupler)	To output any monitoring signal including in operation , frequency attained, overload indicator...etc, please refer to Pr.03-01for MO selection.
MO2	Multi-function Output 2 (Photocoupler)	
MO3	Multi-function Output 3 (Photocoupler)	
MCM	Multi-function output common	Max 48Vdc 50mA

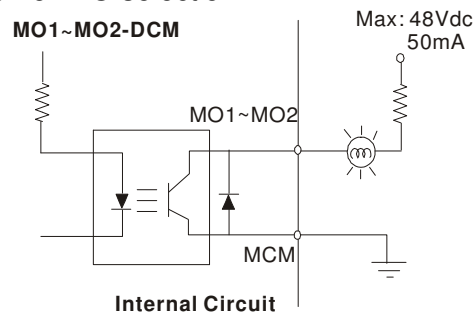

* Analog control signal wiring size: 18 AWG (0.75 mm²) with shielded wire.

Digital Inputs (FWD, REV, MI1~MI8, COM)

- ☑ When using contacts or switches to control the digital inputs, please use high quality components to avoid contact bounce.

Digital Outputs (MO1, MO2, MO3, MCM)

- ☑ Make sure to connect the digital outputs to the right polarity, see wiring diagrams.
- ☑ When connecting a relay to the digital outputs, connect a surge absorber or fly-back diode across the coil and check the polarity.

Chapter 3 Keypad and Start-up

3-1 Operation Method

3-2 Keypad Descriptions



CAUTION

- ☑ Make sure that the wiring is correct. In particular, check that the output terminals U/T1, V/T2, W/T3 are NOT connected to power and that the drive is well grounded.
- ☑ Verify that no other equipment is connected to the AC motor
- ☑ Do NOT operate the AC motor drive with humid hands.
- ☑ Verify that there are no short-circuits between terminals and from terminals to ground or mains power.
- ☑ Check if all connections are proper, there should be no loose terminals, connectors or screws.
- ☑ Make sure that the front cover is well installed before applying power.



WARNING

- ☑ When AC motor drive and motor are not function properly, stops operation immediately and follow malfunction diagnosis to verify the reason of fault. Do not touch U/T1, V/T2, W/T3 before the main power L1, L2 are turned off or electric shock may occur.

3-1 Operation Method

The factory setting of VFD-DD series AC motor drive's operation method is set to external terminal control. But it is just one of the operation methods. The operation method can be via communication, control terminals settings or optional digital keypad. Please choose a suitable method depending on application and operation rule.

Operation Method	Frequency Source	Operation Command Source
Operate from communication	Please refer to the communication address 2000H and 2119H settings in the communication address definition.	

<p>Control Terminals- Operate from external signal</p>	<p style="text-align: center;">Figure 3-1</p>
--	---

<p>Digital Keypad</p>	<p style="text-align: center;">Figure 3-2</p>
-----------------------	---

UP/DOWN key

RUN, STOP/RESET key

3-2 Keypad Descriptions

Descriptions of Digital Keypad Outlook

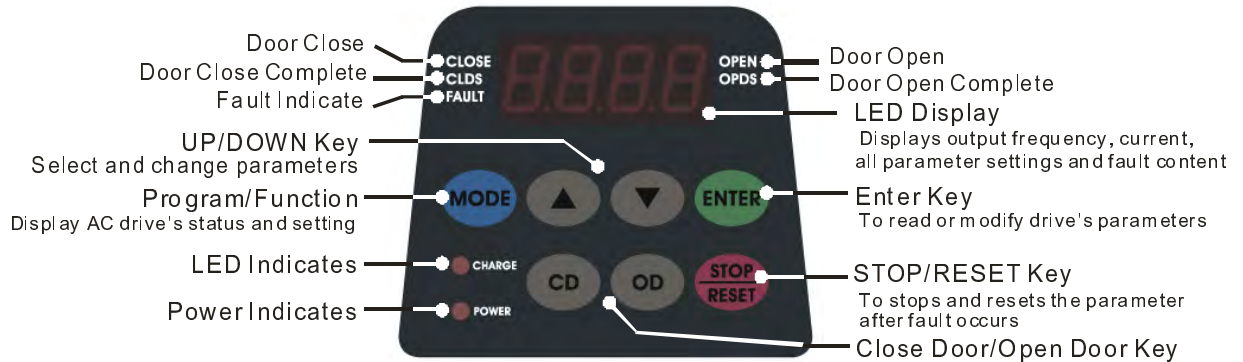

Descriptions of Display Items

Display Message	Descriptions
F500	Displays the AC drive Master Frequency.
H500	Displays the actual output frequency present at the motor.
U600	User defined unit (where U = F x Pr.0-05)
A 50	Displays the output current present at terminals U/T1, V/T2, and W/T3.
C 50	Display counting value
0200	Display the selected parameter
10	Displays the actual stored value of the selected parameter.
EF	External Fault.
End	Display "End" for approximately 1 second if input has been accepted and saved automatically.
Err	Display "Err", if the input is invalid.

How to Operate the Digital Keypad

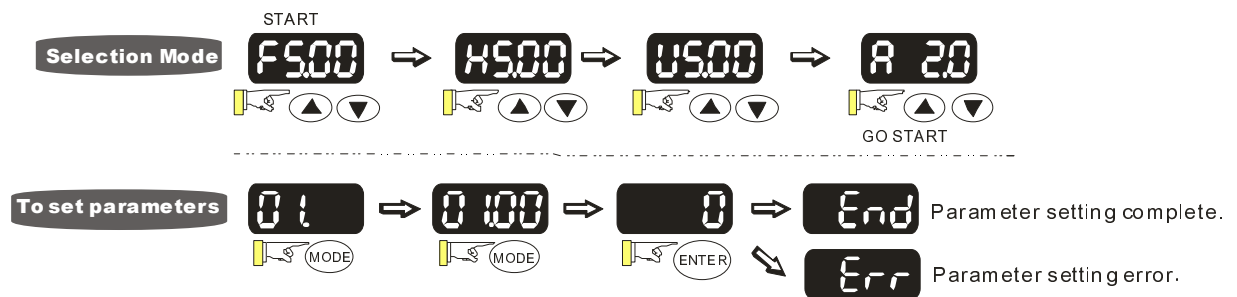

NOTE: In the parameter setting mode, user can return to MODE selection by pressing MODE.

Chapter 4 Parameter Settings

4-1 Summary of Parameter Settings

4-2 Summary of Detailed Parameter Settings

The VFD-DD parameters are divided into 12 groups by property for easy setting. Most of the parameter settings can be done before start-up and readjustment of the parameter will not be needed.

Group 00: System Parameters

Group 01: Motor Parameters

Group 02: Input/Output Parameters

Group 03: Feedback Parameters

Group 04: Door Open Parameters

Group 05: Door Close Parameters

Group 06: Protection and Special Parameters

Group 07: Control Parameters

Group 08: Multi-step Speed Parameters

Group 09: Communication Parameters

Group 10: User-defined Parameters

Group 11: View User-defined Parameters

4-1 Summary of Parameter Settings

00 System Parameters

↗: This parameter can be set during operation.

Parameter	Explanation	Settings	Factory Setting	VF	VFP	SVC	FOC	FOC
00.00	Identity Code of AC motor drive	0: 200w 2: 400w	Read only	○	○	○	○	○
00.01	Rated Current Display of AC motor drive	0: 1.50A 2: 2.50A	Read only	○	○	○	○	○
00.02	Parameter Reset	0: No function 1: Parameters locked 8: Keypad locked 10: All parameters are reset to factory setting (33.3Hz, 230V)	0	○	○	○	○	○
↗00.03	Start-up Display Selection	0: Display the frequency command value (F) 1: Display the actual output frequency (H) 2: Display the content of user-defined unit (U) 3: Display the output current (A)	0	○	○	○	○	○
↗00.04	Content of Multi Function Display	0: Display output current (A) 1: Display actual frequency (Hz) 2: Display DC-BUS voltage (U) 3: Display output voltage(E) 4: Display power factor angle (n.) 5: Display output power (kW) 6: Display motor angle speed (HU) 7: Display the drive's estimated output torque (kg-m) 8: Display PG pulse input position 9: Display the electrical angle 10: Display IGBT temperature(oC) 11: Display digital input ON/OFF status 12: Display digital output ON/OFF status 13: Display current multi-step speed 14: Display the corresponding CPU pin status of digital input 15: Display the corresponding CPU pin status of digital input 16: Actual output voltage when malfunction 17: Actual DC-BUS voltage when malfunction 18: Actual output frequency when malfunction 19: Actual output current when malfunction 20: Actual frequency command when malfunction 21: Door width in % or step speed 22: Door width(pulse) 23: Over modulation indication	2	○	○	○	○	○

Parameter	Explanation	Settings	Factory Setting	VF	VFP	SVC	FOC	FOC
00.05	Software version	Read only(Different versions will display differently)	###	○	○	○	○	○
↗00.06	Password Input	0~9999 0~2:times of wrong password	0	○	○	○	○	○
↗00.07	Password Set	0~9999 0: No password set or successful input in Pr.00-07 1: Password has been set	0	○	○	○	○	○
00.08	Control Method	0: V/f control 1: V/f Control + Encoder (VFPG) 2: Sensorless vector control (SVC) 3: FOC vector control + Encoder (FOCPG) 8: FOC PM control (FOCPM)	0	○	○	○	○	○
00.09	Door Control Mode	0: Distance control mode 1: Reserved 2: Multi-step speed control mode 3: Speed control mode	3	○	○	○	○	○
↗00.10	Output Direction	0: Runs in same direction as setting 1: Runs in different direction than setting	0	○	○	○	○	○
↗00.11	Carrier Frequency Selection	02~15 kHz	10	○	○	○	○	○
↗00.12	Auto Voltage Regulation (AVR) Function	0: Enable AVR 1: Disable AVR 2: Disable AVR when deceleration stop	0	○	○	○	○	○
↗00.13	Source of the Master Frequency Command	0: by digital keypad input 1: by external terminal 2: by RS-485 serial communication	1	○	○	○	○	○
↗00.14	Demo Mode	0: Disable 1: Display demo action	0	○	○	○	○	○
↗00.15	Frequency Testing Command	0~120.00 Hz	0	○	○	○	○	○

01 Motor Parameters

↗: This parameter can be set during operation.

Parameter	Explanation	Settings	Factory Setting	VF	VFP	SVC	FOC	FOC
01.00	Motor Auto Tuning (PM)	0: No function 1: Auto-tuning for PM motor parameters (brake locked) 2: Auto-tuning for PG offset angle without load (Pr.01.09) 3: Auto-tuning for PG offset angle with load (Pr.01.09)	0					○
01.01	Full-load Current of motor (PM)	(40~120%)*00.01 Amps	1.00					○
01.02	Rated power of Motor (PM)	0.00~655.35kW	0.06					○
01.03	Rated speed of Motor (rpm) (PM)	0~65535	250					○
01.04	Number of Motor Poles (PM)	2~96	16					○
01.05	Rs of Motor parameter (PM)	0.0~655.35Ω	13.900					○
01.06	Ld of Motor Parameter (PM)	0.0~6553.5mH	169.4					○
01.07	Lq of Motor Parameter (PM)	0.0~6553.5mH	169.4					○
01.08	Back Electromotive Force (PM)	0.0~6553.5Vrms	0.0					○
01.09	Angle between Magnetic Pole and PG Origin (PM)	0.0~360.0°	360.0					○
01.10	Magnetic Pole Re-orientation (PM)	0:No function 1:Reset magnetic pole position	0					○
01.11	Motor Auto Tuning (IM)	0: No function 1: Rolling test 2: Static test 3: Reserved	0			○	○	
01.12	Full-load Current of Motor (IM)	(40~120%)*00.01 Amps	1.00	○	○	○	○	
01.13	Rated power of Motor (IM)	0.00~655.35kW	0.06			○	○	
01.14	Rated speed of Motor (rpm) (IM)	0~65535	250		○	○	○	
01.15	Number of Motor Poles (IM)	2~48	16	○	○	○	○	
01.16	No-load Current of Motor (IM)	00~ Pr.01.12 factory setting	###		○	○	○	
01.17	Rs of Motor (IM)	0.000~65.535mΩ	0.000			○	○	
01.18	Rr of Motor (IM)	0.000~65.535mΩ	0.000			○	○	
01.19	Lm of Motor (IM)	0.0~6553.5mH	0.0			○	○	
01.20	Lx of Motor (IM)	0.0~6553.5mH	0.0			○	○	
↗01.21	Torque Compensation Time Constant	0.001~10.000sec	0.020			○		

Parameter	Explanation	Settings	Factory Setting	VF	VFP	SVC	FOC	FOC
↗01.22	Slip Compensation Time Constant	0.001~10.000sec	0.100			○		
↗01.23	Torque Compensation Gain	00~10	0	○	○			
↗01.24	Slip Compensation Gain	0.00~10.00	0.00	○	○	○		
↗01.25	Slip Deviation Level	00~1000% (0:Disable)	0		○	○	○	
↗01.26	Detection Time of Slip Deviation	0.0~10.0sec	1.0		○	○	○	
↗01.27	Over Slip Treatment	0: Warn and keep operation 1: Warn and ramp to stop 2: Warn and coast to stop	0		○	○	○	
↗01.28	Hunting Gain	00~10000 (0:Disable)	2000	○	○	○		
01.29	Accumulative Motor Operation Time (Min.)	0~1439	0	○	○	○	○	
01.30	Accumulative Motor Operation Time (day)	0~65535	0	○	○	○	○	
01.31	Maximum Output Frequency	10.00~120.00Hz	50	○	○	○	○	○
01.32	Output Frequency 1 (Base frequency /Motor rated frequency)	0.00~120.00Hz	50	○	○	○	○	○
01.33	Output Voltage 1(Base voltage/Motor rated voltage)	0.0V~240.0V	220.0	○	○	○	○	○
01.34	Output Frequency 2	0.00~120.00Hz	0.50	○	○			
↗01.35	Output Voltage 2	0.0V~240.0V	5.0	○	○			
01.36	Output Frequency 3	0.00~120.00Hz	0.50	○	○			
↗01.37	Output Voltage 3	0.0V~240.0V	5.0	○	○			
01.38	Output Frequency 4	0.00~120.00Hz	0.00	○	○	○	○	
↗01.39	Output Voltage 4	0.0V~240.0V	0.0	○	○			

02 Input/Output Parameters

↗: This parameter can be set during operation.

Parameter	Explanation	Settings	Factory Setting	VF	VFP	SVC	FOC	FOC
02.00	2-wire/3-wire Operation Control	0: 2-wire mode 1 (when power is on, operation begins) 1: 2-wire mode 1 (when power is on, no operation) 2: 2-wire mode 2 (when power is on, operation begins) 3: 2-wire mode 2 (when power is on, no operation)	0	○	○	○	○	○
02.01	Multi-Function Input 1 (MI1)	0: No function	14	○	○	○	○	○
02.02	Multi-Function Input 2 (MI2)	1: Multi-step speed command 1	15	○	○	○	○	○
02.03	Multi-Function Input 3 (MI3)	2: Multi-step speed command 2	16	○	○	○	○	○
02.04	Multi-Function Input 4 (MI4)	3: Multi-step speed command 3	17	○	○	○	○	○
02.05	Multi-Function Input 5 (MI5)	4: Multi-step speed command 4	0	○	○	○	○	○
		5: Fault reset		○	○	○	○	○
		6: Low speed operation		○	○	○	○	○
		7: FWD/REV command for low speed operation		○	○	○	○	○
		8: 1st, 2nd acceleration/deceleration time selection		○	○	○	○	○
		9: Force stop (NO) input		○	○	○	○	○
		10: Demo mode		○	○	○	○	○
		11: Emergency stop (NO) input		○	○	○	○	○
		12: Source of operation command (Keypad/External terminals)		○	○	○	○	○
		13: Parameter lock enable (NC)		○	○	○	○	○
		14: Door open complete signal		○	○	○	○	○
		15: Door close complete signal		○	○	○	○	○
		16: Door open speed switch signal		○	○	○	○	○
		17: Door close speed switch signal		○	○	○	○	○
18: Open allowance signal	○	○	○	○	○			
19: Screen signal input	○	○	○	○	○			
20: Door curve signal input for 2nd set door open/close	○	○	○	○	○			
21: Reset signal input	○	○	○	○	○			
↗02.06	Digital Terminal Input Debouncing Time	0.001~30.000sec	0.005	○	○	○	○	○
↗02.07	Digital Input Operation Direction	0~65535	60	○	○	○	○	○
↗02.08	Multi-function Output (Relay1)	0: No function	16	○	○	○	○	○
↗02.09	Multi-function Output (Relay2)	1: AC drive in operation	17	○	○	○	○	○
↗02.10	Multi-function Output (MO1)	2: Zero speed frequency signal (including STOP)	0	○	○	○	○	○

Parameter	Explanation	Settings	Factory Setting	VF	VFP	SVC	FOC	FOC
↗02.11	Multi-function Output (MO2)	3: AC drive ready	0	○	○	○	○	○
↗02.12	Multi-function Output (MO3) (Communication)	4: Low voltage warning(Lv)	0	○	○	○	○	○
		5: Fault indication		○	○	○	○	○
		6: Overhead warning (Pr.06.09)		○	○	○	○	○
		7: Detection of braking resistor action level		○	○	○	○	○
		8: Warning indication		○	○	○	○	○
		9: Over voltage warning		○	○	○	○	○
		10: FWD command		○	○	○	○	○
		11: REV command		○	○	○	○	○
		12: Demo Indication		○	○	○	○	○
		13: Demo complete		○	○	○	○	○
		14: Force stop indication		○	○	○	○	○
		15: Emergency stop indication		○	○	○	○	○
		16: Signal output for door close complete		○	○	○	○	○
		16: Door close complete (limit) signal output		○	○	○	○	○
		17: Door open complete (limit) signal output		○	○	○	○	○
18: Door close error	○	○	○	○	○			
		19: Position Complete Signal		○	○	○	○	○
		20: Position Detection 1(for door close only)		○	○	○	○	○
		21: Position Detection 2(for door close only)		○	○	○	○	○
		22: Position Detection 3(for door close only))		○	○	○	○	○
		23: Position Detection 1(for door open only)		○	○	○	○	○
		24: Position Detection 2(for door open only)		○	○	○	○	○
		25: Position Detection 3(for door open only)		○	○	○	○	○
		26: PG feedback error		○	○	○	○	○
↗02.13	Multi-function Output Direction	0~65535	0	○	○	○	○	○
↗02.14	Position Detection Signal 1	0.0~100.0%	25.0	○	○	○	○	○
↗02.15	Position Detection Signal 2	0.0~100.0%	12.5	○	○	○	○	○
↗02.16	Position Detection Signal 3	0.0~100.0%	7.5	○	○	○	○	○

03 Feedback Parameters

✎ This parameter can be set during

operation.

Parameter	Explanation	Settings	Factory Setting	VF	VFP	SVC	FOC	FOC
03.00	Encoder (PG) Signal Type	0: No function 1: ABZ 7: PWM pulse	7		○		○	○
03.01	Encoder pulse	1~25000	256		○		○	○
03.02	Encoder Input Type Setting	0: Disable 1: Phase A leads in a forward run command and phase B leads in a reverse run command 2: Phase B leads in a forward run command and phase A leads in a reverse run command 3: Phase A is a pulse input and phase B is a direction input. (low input=reverse direction, high input=forward direction) 4: Phase A is a pulse input and phase B is a direction input. (low input=forward direction, high input=reverse direction) 5: Single-phase input	1		○		○	○
✎03.03	Encoder Feedback Fault Treatment (PGF1, PGF2)	0: Warn and keep operation 1: Warn and ramp to stop 2: Warn and stop operation	2		○		○	○
✎03.04	Detection Time for Encoder Feedback Fault	0.0~10.0sec	1.0		○		○	○
✎03.05	Encoder Stall Level (PGF3)	0~120% (0:Disable)	115		○	○	○	○
✎03.06	Encoder Stall Detection Time	0.0~2.0sec	0.1		○	○	○	○
✎03.07	Encoder Slip Range (PGF4)	0~50% (0:Disable)	50		○	○	○	○
✎03.08	Encoder Slip Detection Time	0.0~10.0sec	0.5		○	○	○	○
✎03.09	Encoder Stall and Slip Error Treatment	0: Warn and keep operation 1: Warn and ramp to stop 2: Warn and coast to stop	2		○	○	○	
03.10	Door Width Auto-tuning Frequency	0.10~120.00Hz	5.0	○	○	○	○	○
03.11	Door Width Auto-tuning	0: Disable 1: Enable	0	○	○	○	○	○
03.12	Door Width Pulse (Unit:1)	1~9999	8800	○	○	○	○	○
03.13	Door Width Pulse (Unit:10000)	0~9999 (Unit:10000)	0	○	○	○	○	○

04 Door Open Parameters

✎ This parameter can be set during operation.

Parameter	Explanation	Settings	Factory Setting	VF	VFP	SVC	FOC	FOC
✎04.00	Door Open by Initial Speed	0.00~120.0Hz	2.00	<input type="radio"/>	<input type="radio"/>	<input type="radio"/>	<input type="radio"/>	<input type="radio"/>
✎04.01	Door Open Distance by Initial Speed	0~65535 (Unit: pulses number)	300	<input type="radio"/>	<input type="radio"/>	<input type="radio"/>	<input type="radio"/>	<input type="radio"/>
✎04.02	Door Open Time by Initial Speed	0~20.0s	1.0	<input type="radio"/>	<input type="radio"/>	<input type="radio"/>	<input type="radio"/>	<input type="radio"/>
✎04.03	Door Open High Speed 1	0.00~120.0Hz	15.00	<input type="radio"/>	<input type="radio"/>	<input type="radio"/>	<input type="radio"/>	<input type="radio"/>
✎04.04	Door Open by Final Speed Begins	0.0~100.0% (Door width setting in %)	90.0	<input type="radio"/>	<input type="radio"/>	<input type="radio"/>	<input type="radio"/>	<input type="radio"/>
✎04.05	Door Open Final Speed	0.00~120.0Hz	5.00	<input type="radio"/>	<input type="radio"/>	<input type="radio"/>	<input type="radio"/>	<input type="radio"/>
✎04.06	Door Open by Holding Speed Begins	0.0~100.0% (Door width setting in %)	95.0	<input type="radio"/>	<input type="radio"/>	<input type="radio"/>	<input type="radio"/>	<input type="radio"/>
✎04.07	Door Open Holding Speed	0.00~120.0Hz	2.00	<input type="radio"/>	<input type="radio"/>	<input type="radio"/>	<input type="radio"/>	<input type="radio"/>
✎04.08	Door Open Acceleration Time 1	0.1~3600sec	1.0	<input type="radio"/>	<input type="radio"/>	<input type="radio"/>	<input type="radio"/>	<input type="radio"/>
✎04.09	Door Open Deceleration Time 1	0.1~3600sec	1.0	<input type="radio"/>	<input type="radio"/>	<input type="radio"/>	<input type="radio"/>	<input type="radio"/>
✎04.10	Door Open Holding Torque Level	0.0~150.0% (AC drive's rated current)	50.0	<input type="radio"/>	<input type="radio"/>	<input type="radio"/>	<input type="radio"/>	<input type="radio"/>
✎04.11	Door Open Holding Torque	0.0~100.0% (AC drive's rated current)	30.0	<input type="radio"/>	<input type="radio"/>	<input type="radio"/>	<input type="radio"/>	<input type="radio"/>
✎04.12	Response Time of Door Open Holding Torque	0.01~10.00sec	0.20	<input type="radio"/>	<input type="radio"/>	<input type="radio"/>	<input type="radio"/>	<input type="radio"/>
✎04.13	Door Open High Speed 2	0.00~400.0Hz	30.00	<input type="radio"/>	<input type="radio"/>	<input type="radio"/>	<input type="radio"/>	<input type="radio"/>
✎04.14	Door Open Acceleration Time 2	0.1~3600sec	1.0	<input type="radio"/>	<input type="radio"/>	<input type="radio"/>	<input type="radio"/>	<input type="radio"/>
✎04.15	Door Open Deceleration Time 2	0.1~3600sec	1.0	<input type="radio"/>	<input type="radio"/>	<input type="radio"/>	<input type="radio"/>	<input type="radio"/>
✎04.16	Door Open Holding Torque 2	0.0~150.0% (AC drive's rated current)	0.0	<input type="radio"/>	<input type="radio"/>	<input type="radio"/>	<input type="radio"/>	<input type="radio"/>
04.17	Door Open Time-out Setting	0.0~180.0sec (0.0 sec: Disable)	0.0	<input type="radio"/>	<input type="radio"/>	<input type="radio"/>	<input type="radio"/>	<input type="radio"/>
✎04.18	Holding Time for OD (Open Door)Terminal	0.0~999.9sec (999.9 sec for always holding)	0.0	<input type="radio"/>	<input type="radio"/>	<input type="radio"/>	<input type="radio"/>	<input type="radio"/>
✎04.19	Door Open Acceleration Time of S1 Curve	0.0~10.0sec	0.0	<input type="radio"/>	<input type="radio"/>	<input type="radio"/>	<input type="radio"/>	<input type="radio"/>
✎04.20	Door Open Acceleration Time of S2 Curve	0.0~10.0sec	0.0	<input type="radio"/>	<input type="radio"/>	<input type="radio"/>	<input type="radio"/>	<input type="radio"/>
✎04.21	Door Open DC Brake Current Level	00~100%	0	<input type="radio"/>	<input type="radio"/>	<input type="radio"/>	<input type="radio"/>	<input type="radio"/>
✎04.22	Door Open DC Brake Time when Startup	0.0~60.0sec	0.0	<input type="radio"/>	<input type="radio"/>	<input type="radio"/>	<input type="radio"/>	<input type="radio"/>
✎04.23	Door Open DC Brake Time when Stopping	0.0~60.0sec	0.0	<input type="radio"/>	<input type="radio"/>	<input type="radio"/>	<input type="radio"/>	<input type="radio"/>
✎04.24	Door Open DC Brake Starting Frequency	0.00~120.00Hz	0.00	<input type="radio"/>	<input type="radio"/>	<input type="radio"/>	<input type="radio"/>	<input type="radio"/>

05 Door Close Parameters

⚡ This parameter can be set during operation.

Parameter	Explanation	Settings	Factory Setting	VF	VFP	SVC	FOC	FOC
⚡ 05.00	Door Close Initial Speed	0.00~120.0Hz	2.00	○	○	○	○	○
⚡ 05.01	Door Close Distance by Initial Speed	0~65535 (Unit: pulses number)	0	○	○	○	○	○
⚡ 05.02	Door Close Time by Initial Speed	0~20.0s	0	○	○	○	○	○
⚡ 05.03	Door Close High Speed 1	0.00~120.0Hz	15.00	○	○	○	○	○
⚡ 05.04	Door Close by Final Speed Begins	0.0~100.0% (Door width setting in %)	10.0	○	○	○	○	○
⚡ 05.05	Door Close Final Speed	0.00~120.0Hz	5.00	○	○	○	○	○
⚡ 05.06	Door Close by Holding Speed Begins	0.0~100.0% (Door width setting in %)	5.0	○	○	○	○	○
⚡ 05.07	Door Close Holding Speed	0.00~120.0Hz	2.00	○	○	○	○	○
⚡ 05.08	Door Close Acceleration Time 1	0.1~3600sec	1.0	○	○	○	○	○
⚡ 05.09	Door Close Deceleration Time 1	0.1~3600sec	1.0	○	○	○	○	○
⚡ 05.10	Door Close Holding Torque Level 1	0.0~150.0% (Drive's rated current)	50.0	○	○	○	○	○
⚡ 05.11	Door Close Holding Torque 1	0.0~100.0% (Drive's rated current)	30.0	○	○	○	○	○
⚡ 05.12	Response Time of Door Close Holding Torque	0.01~10.00sec	0.20	○	○	○	○	○
⚡ 05.13	Door Close High Speed 2	0.00~120.0Hz	30.00	○	○	○		
⚡ 05.14	Door Close Acceleration Time 2	0.1~3600sec	1.0	○	○	○	○	○
⚡ 05.15	Door Close Deceleration Time 2	0.1~3600sec	1.0	○	○	○	○	○
⚡ 05.16	Door Close Holding Torque Level 2	0.0~150.0% (Ac drive's rated current)	0.0	○	○	○	○	○
⚡ 05.17	Door Close Time-out Setting	0.0~180.0sec (0.0sec:Disable)	0.0	○	○	○	○	○
⚡ 05.18	Holding Time for CD (Close Door)Terminal	0.0~999.9sec (999.9sec is always holding)	0.0	○	○	○	○	○
⚡ 05.19	Door Close Acceleration Time of S1 Curve	0.0~10.0sec	0.0	○	○	○	○	○
⚡ 05.20	Door Close Acceleration Time of S2 Curve	0.0~10.0sec	0.0	○	○	○	○	○
⚡ 05.21	Door Close DC Brake Current Level	0~100%	0	○	○	○		
⚡ 05.22	Door Close DC Brake Time when Startup	0.0~60.0sec	0.0	○	○	○	○	○
⚡ 05.23	Door Close DC Brake Time when Stopping	0.0~60.0sec	0.0	○	○	○	○	○

Parameter	Explanation	Settings	Factory Setting	VF	VFP	SVC	FOC	FOC
↗05.24	Door Close DC Brake Starting Frequency	0.00~120.00Hz	0.00	<input type="radio"/>	<input type="radio"/>	<input type="radio"/>	<input type="radio"/>	<input type="radio"/>
05.25	Door Re-open Current Level 1	0.0~150.0% (AC drive's rated current)	100.0	<input type="radio"/>	<input type="radio"/>	<input type="radio"/>	<input type="radio"/>	<input type="radio"/>
↗05.26	Door Re-open Current Level 1 for Acceleration Area	100~200% (100% is Pr.05.25 setting)	150	<input type="radio"/>	<input type="radio"/>	<input type="radio"/>	<input type="radio"/>	<input type="radio"/>
↗05.27	Door Re-open Current Level 1 for Low Speed Area	0.0~150.0%(Drive's rated current)	100.0	<input type="radio"/>	<input type="radio"/>	<input type="radio"/>	<input type="radio"/>	<input type="radio"/>
05.28	Door Re-open Current Level 2	0.0~150.0%(Drive's rated current)	100.0	<input type="radio"/>	<input type="radio"/>	<input type="radio"/>	<input type="radio"/>	<input type="radio"/>
↗05.29	Door Re-open Current Level 2 for Acceleration Area	0.0~150.0% (Drive's rated current)	150	<input type="radio"/>	<input type="radio"/>	<input type="radio"/>	<input type="radio"/>	<input type="radio"/>
↗05.30	Door Re-open Current Level 2 for Low Speed Area	100~200%(100% is Pr.05.29 setting)	100	<input type="radio"/>	<input type="radio"/>	<input type="radio"/>	<input type="radio"/>	<input type="radio"/>
↗05.31	Door Re-open Low Speed Boundary	1.0~99.0%(Total door width=100%; range between 0%~Pr.05.31 is excluded from low speed detection area)	2.0	<input type="radio"/>	<input type="radio"/>	<input type="radio"/>	<input type="radio"/>	<input type="radio"/>
↗05.32	Door Re-open Acceleration Boundary	8.0~97.0%(Total door width =100%; range between Pr.05.32~100% is the acceleration area)	70.0	<input type="radio"/>	<input type="radio"/>	<input type="radio"/>	<input type="radio"/>	<input type="radio"/>
↗05.33	Door Close Error Deceleration Time	0.1~3600sec	0.4	<input type="radio"/>	<input type="radio"/>	<input type="radio"/>	<input type="radio"/>	<input type="radio"/>
↗05.34	Door Re-open Detection Time	0~10.0sec	0.2	<input type="radio"/>	<input type="radio"/>	<input type="radio"/>	<input type="radio"/>	<input type="radio"/>

06 Protection and Special Parameters

✎ This parameter can be set during operation.

Parameter	Explanation	Settings	Factory Setting	VF	VFP	SVC	FOC	FOC
✎06.00	Software Braking Level	350.0~450.0Vdc	380.0	○	○	○	○	○
✎06.01	ED Setting of Brake Resistor	0~100%	50	○	○	○	○	○
✎06.02	Current Boundary	0~250%	200				○	○
✎06.03	Forward Motor Torque Limit	0~300%	200				○	○
✎06.04	Forward Regenerative Torque Limit	0~300%	200				○	○
✎06.05	Reverse Motor Torque Limit	0~300%	200				○	○
✎06.06	Reverse Regenerative Torque Limit	0~300%	200				○	○
✎06.07	Emergency/Force Stop Deceleration Method	0:Coast to stop 1: Decelerate by 1st decel. time 2: Decelerate by 2nd decel. time 3:By Pr.05.33 setting	3	○	○	○	○	○
✎06.08	Low Voltage Level	160.0~220.0Vdc	180.0	○	○	○	○	○
✎06.09	High Temperature Overheat Warning (OH)	0.0~110.0°C	85.0	○	○	○	○	○
06.10	Action after door re-open/re-close	Bit 0=0:Not detecting incorrect open/close limit Bit 0=1:Detects incorrect open/close limit Bit 1=0:Door re-open when door close error occur Bit 1=1:Door will not re-open when door close error occur Bit 2=0:Enable S-Curve when door re-open Bit 2=1:Disable S-Curve when door re-open Bit 3=0: When door open complete, will not reset door position to 100.0%. Bit 3=1:When door open complete, resets door position to 100.0%	2	○	○	○	○	○
✎06.11	Position Control Mode	0: No limit signal, detect by PG number and current level. 1: Door open limit signal only, door close by PG number or current level detection. 2: Door close limit signal only · door open by PG number or current level detection. 3: Door open and close limit signal 4: Detect by PG number and also accept external door open/close limit signal 5: No limit signal, detect by PG number and current level. (For Pr.00-09=3 speed control mode)	0	○	○	○	○	○

Parameter	Explanation	Settings	Factory Setting	VF	VFP	SVC	FOC	FOC
↗06.12	Stall Current Level of Position Mode	0.0~200.0% (Drive's rated current)	30.0	○	○	○	○	○
↗06.13	Door Open/Close Holding Time Before Next Demo	0.0~999.9sec	2.0	○	○	○	○	○
06.14	Times of Door Open/Close in Demo Mode (L)	0~9999	0	○	○	○	○	○
06.15	Times of Door Open/Close in Demo Mode (H)	0~9999	0	○	○	○	○	○
06.16	Clear Demo Mode Door Open/Close Record	0: Disable 1: Clear (Pr.06.14 and Pr.06.15)	0	○	○	○	○	○
06.17	Present Fault Record	0: No fault	0	○	○	○	○	○
06.18	2nd Most Recent Fault Record	1: Over-current during acceleration (ocA)	0	○	○	○	○	○
06.19	3rd Most Recent Fault Record	2: Over-current during deceleration (ocd)	0	○	○	○	○	○
06.20	4th Most Recent Fault Record	3: Over-current during steady speed (ocn)	0	○	○	○	○	○
06.21	5th Most Recent Fault Record	4: Reserved	0	○	○	○	○	○
06.22	6th Sixth Most Recent Fault Record	5: Reserved	0	○	○	○	○	○
		6: Over-current at stop (ocS)	0	○	○	○	○	○
		7: Over voltage during acceleration (ovA)	0	○	○	○	○	○
		8 Over voltage during deceleration (ovd)	0	○	○	○	○	○
		9: Over voltage during steady speed (ovn)	0	○	○	○	○	○
		10: Over voltage at stop (ovS)	0	○	○	○	○	○
		11: Low voltage during acceleration (LvA)	0	○	○	○	○	○
		12: Low voltage during deceleration (Lvd)	0	○	○	○	○	○
		13: Low voltage during steady speed (Lvn)	0	○	○	○	○	○
		14:Low voltage at stop (LvS)	0	○	○	○	○	○
		15:Phase loss protection (PHL)	0	○	○	○	○	○
		16:IGBT overheat (oH1)	0	○	○	○	○	○
		17:Reserved	0	○	○	○	○	○
		18: IGBT overheat protection circuit error (tH1o)	0	○	○	○	○	○
		19~20: Reserved	0	○	○	○	○	○
		21: 150% 1Min, AC drive overload (oL)	0	○	○	○	○	○
		22: Motor overload (EoL1)	0	○	○	○	○	○
		23~29: Reserved	0	○	○	○	○	○
		30: Memory write-in error (cF1)	0	○	○	○	○	○
		31: Memory read-out error (cF2)	0	○	○	○	○	○

Parameter	Explanation	Settings	Factory Setting	VF	VFP	SVC	FOC	FOC
		32: Isum current detection error (cd0)	0	○	○	○	○	○
		33: U-phase current detection error (cd1)	0	○	○	○	○	○
		34: V-phase current detection error (cd2)	0	○	○	○	○	○
		35: W-phase current detection error (cd3)	0	○	○	○	○	○
		36: Clamp current detection error (Hd0)	0	○	○	○	○	○
		37: Over-current detection error (Hd1)	0	○	○	○	○	○
		38: Over-voltage detection error (Hd2)	0	○	○	○	○	○
		39: Ground current detection error (Hd3)	0	○	○	○	○	○
		40: Auto tuning error (AuE)	0	○	○	○	○	○
		41: Reserved	0	○	○	○	○	○
		42: PG feedback error (PGF1)	0	○	○	○	○	○
		43: PG feedback loss (PGF2)	0	○	○	○	○	○
		44: PG feedback stall (PGF3)	0	○	○	○	○	○
		45: PG slip error (PGF4)	0	○	○	○	○	○
		46~48:Reserved	0	○	○	○	○	○
		49:External fault signal input	0	○	○	○	○	○
		50~51: Reserved	0	○	○	○	○	○
		52:Password error (PcodE)	0	○	○	○	○	○
		53:Software error (ccodE)	0	○	○	○	○	○
		54:Communication time-out (cE1)	0	○	○	○	○	○
		55: Communication time-out (cE2)	0	○	○	○	○	○
		56: Communication time-out (cE3)	0	○	○	○	○	○
		57: Communication time-out (cE4)	0	○	○	○	○	○
		58 Communication time-out (cE10)	0	○	○	○	○	○
		59:PU time-out (cP10)	0	○	○	○	○	○
		60: Brake chopper error (bF)	0	○	○	○	○	○
		61~67: Reserved	0	○	○	○	○	○
		68: Door open/close complete signal error	0	○	○	○	○	○
		69:Door open time-out (DOT)	0	○	○	○	○	○
↗06.23	Electronic Thermal Overload Relay Selection	0: Special motor for AC drive 1: Standard motor 2: Disable	2					
↗06.24	Electronic Thermal Characteristic	30.0~600.0sec	60.0	○	○	○	○	○
↗06.25	Auto Restart After Fault	0~10	0	○	○	○	○	○
↗06.26	Auto Reset Time for Restart after Fault	0.1~600.0	60.0	○	○	○	○	○

07 Control Parameters

✎ This parameter can be set during operation.

Parameter	Explanation	Settings	Factory Setting	V/F	VFP	SVC	FOC	FOC
✎07.00	ASR (Auto Speed Regulation) Control (P) of Zero Speed	0.0~500.0%	1.5	<input type="radio"/>	<input type="radio"/>	<input type="radio"/>	<input type="radio"/>	<input type="radio"/>
✎07.01	ASR (Auto Speed Regulation) Control (I) of Zero Speed	0.000~10.000sec	0.05	<input type="radio"/>	<input type="radio"/>	<input type="radio"/>	<input type="radio"/>	<input type="radio"/>
✎07.02	ASR (Auto Speed Regulation) Control (P) 1	0.0~500.0%	1.5	<input type="radio"/>	<input type="radio"/>	<input type="radio"/>	<input type="radio"/>	<input type="radio"/>
✎07.03	ASR (Auto Speed Regulation) Control (I) 1	0.000~10.000sec	0.05	<input type="radio"/>	<input type="radio"/>	<input type="radio"/>	<input type="radio"/>	<input type="radio"/>
✎07.04	ASR (Auto Speed Regulation) Control (P) 2	0.0~500.0%	3.0	<input type="radio"/>	<input type="radio"/>	<input type="radio"/>	<input type="radio"/>	<input type="radio"/>
✎07.05	ASR (Auto Speed Regulation) Control (I) 2	0.000~10.000sec	0.10	<input type="radio"/>	<input type="radio"/>	<input type="radio"/>	<input type="radio"/>	<input type="radio"/>
✎07.06	ASR 1/ASR2 Switch Frequency	0.00~400.00Hz (0:Disable)	2.00	<input type="radio"/>	<input type="radio"/>	<input type="radio"/>	<input type="radio"/>	<input type="radio"/>
✎07.07	ASR Primary Low Pass Filter Gain	0.000~0.350sec	0.008	<input type="radio"/>	<input type="radio"/>	<input type="radio"/>	<input type="radio"/>	<input type="radio"/>
✎07.08	Zero Speed/ASR1 Width Adjustment	0.00~400.00Hz	2.00	<input type="radio"/>	<input type="radio"/>	<input type="radio"/>	<input type="radio"/>	<input type="radio"/>
✎07.09	ASR1/ASR2 Width Adjustment	0.00~400.00Hz	5.00	<input type="radio"/>	<input type="radio"/>	<input type="radio"/>	<input type="radio"/>	<input type="radio"/>
07.10	Mechanical Gear Ratio	1~100	1	<input type="radio"/>	<input type="radio"/>	<input type="radio"/>	<input type="radio"/>	<input type="radio"/>
07.11	Inertia Ratio	1~300%	100	<input type="radio"/>	<input type="radio"/>	<input type="radio"/>	<input type="radio"/>	<input type="radio"/>
07.12	Zero-speed Bandwidth	0~40Hz	20	<input type="radio"/>	<input type="radio"/>	<input type="radio"/>	<input type="radio"/>	<input type="radio"/>
07.13	Low-speed Bandwidth	0~40Hz	20	<input type="radio"/>	<input type="radio"/>	<input type="radio"/>	<input type="radio"/>	<input type="radio"/>
07.14	High-speed Bandwidth	0~40Hz	20	<input type="radio"/>	<input type="radio"/>	<input type="radio"/>	<input type="radio"/>	<input type="radio"/>
07.15	PDFF Gain Value	0~200%	0	<input type="radio"/>	<input type="radio"/>	<input type="radio"/>	<input type="radio"/>	<input type="radio"/>
07.16	Gain for Speed Feed Forward	0~500	0	<input type="radio"/>	<input type="radio"/>	<input type="radio"/>	<input type="radio"/>	<input type="radio"/>

08 Multi-step Speed Parameter

⚡ This parameter can be set during operation.

Parameter	Explanation	Settings	Factory Setting	VF	VFP	SVC	FOC	FOC
⚡08.00	Zero Step Speed Frequency	0.00~120.00Hz	0.00	○	○	○	○	○
⚡08.01	1st Step Speed Frequency	0.00~120.00Hz	0.00	○	○	○	○	○
⚡08.02	2nd Step Speed Frequency	0.00~120.00Hz	0.00	○	○	○	○	○
⚡08.03	3rd Step Speed Frequency	0.00~120.00Hz	0.00	○	○	○	○	○
⚡08.04	4th Step Speed Frequency	0.00~120.00Hz	0.00	○	○	○	○	○
⚡08.05	5th Step Speed Frequency	0.00~120.00Hz	0.00	○	○	○	○	○
⚡08.06	6th Step Speed Frequency	0.00~120.00Hz	0.00	○	○	○	○	○
⚡08.07	7th Step Speed Frequency	0.00~120.00Hz	0.00	○	○	○	○	○
⚡08.08	8th Step Speed Frequency	0.00~120.00Hz	0.00	○	○	○	○	○
⚡08.09	9th Step Speed Frequency	0.00~120.00Hz	0.00	○	○	○	○	○
⚡08.10	10th Step Speed Frequency	0.00~120.00Hz	0.00	○	○	○	○	○
⚡08.11	11th Step Speed Frequency	0.00~120.00Hz	0.00	○	○	○	○	○
⚡08.12	12th Step Speed Frequency	0.00~120.00Hz	0.00	○	○	○	○	○
⚡08.13	13th Step Speed Frequency	0.00~120.00Hz	0.00	○	○	○	○	○
⚡08.14	14th Step Speed Frequency	0.00~120.00Hz	0.00	○	○	○	○	○
⚡08.15	15th Step Speed Frequency	0.00~120.00Hz	0.00	○	○	○	○	○

09 Communication Parameters

✎ This parameter can be set during operation.

Parameter	Explanation	Settings	Factory Setting	VF	VFP	SVC	FOC	FOC
✎09.00	Communication Address	01~254	1	<input type="radio"/>	<input type="radio"/>	<input type="radio"/>	<input type="radio"/>	<input type="radio"/>
✎09.01	Transmission Speed	4.8~115.2Kbps	19.2	<input type="radio"/>	<input type="radio"/>	<input type="radio"/>	<input type="radio"/>	<input type="radio"/>
✎09.02	Transmission Fault Treatment	0: Warn and keep operation 1: Warn and ramp to stop 2: Reserved 3: No action and no display	3	<input type="radio"/>	<input type="radio"/>	<input type="radio"/>	<input type="radio"/>	<input type="radio"/>
✎09.03	Time-out Detection	0.0~100.0sec	0.0	<input type="radio"/>	<input type="radio"/>	<input type="radio"/>	<input type="radio"/>	<input type="radio"/>
✎09.04	Communication Protocol	0: 7N1 (ASCII) 1: 7N2 (ASCII) 2: 7E1 (ASCII) 3: 7O1 (ASCII) 4: 7E2 (ASCII) 5: 7O2 (ASCII) 6: 8N1 (ASCII) 7: 8N2 (ASCII) 8: 8E1 (ASCII) 9: 8O1 (ASCII) 10: 8E2 (ASCII) 11: 8O2 (ASCII) 12: 8N1 (RTU) 13: 8N2 (RTU) 14: 8E1 (RTU) 15: 8O1 (RTU) 16: 8E2 (RTU) 17: 8O2 (RTU)	13	<input type="radio"/>	<input type="radio"/>	<input type="radio"/>	<input type="radio"/>	<input type="radio"/>
✎09.05	Response Delay Time	0.0~200.0ms	2.0	<input type="radio"/>	<input type="radio"/>	<input type="radio"/>	<input type="radio"/>	<input type="radio"/>

10 User-defined Parameters

✎ This parameter can be set during operation.

Group 10 shows the explanation for the “User-defined Parameters” from Group 00~09

Parameter	Explanation	Settings	Factory Setting	VF	VFP	SVC	FOC	FOC
✎ 10.00	Start-up Display Selection	0003	Read only	<input type="radio"/>	<input type="radio"/>	<input type="radio"/>	<input type="radio"/>	<input type="radio"/>
✎ 10.01	Maximum Operation Frequency	0131	Read only	<input type="radio"/>	<input type="radio"/>	<input type="radio"/>	<input type="radio"/>	<input type="radio"/>
✎ 10.02	Motor Rated Frequency	0132	Read only	<input type="radio"/>	<input type="radio"/>	<input type="radio"/>	<input type="radio"/>	<input type="radio"/>
✎ 10.03	Motor Rated Voltage	0133	Read only	<input type="radio"/>	<input type="radio"/>	<input type="radio"/>	<input type="radio"/>	<input type="radio"/>
✎ 10.04	2nd Output Frequency (Mid-point frequency)	0134	Read only	<input type="radio"/>	<input type="radio"/>	<input type="radio"/>	<input type="radio"/>	<input type="radio"/>
✎ 10.05	2nd Output Voltage (Mid-point voltage)	0135	Read only	<input type="radio"/>	<input type="radio"/>	<input type="radio"/>	<input type="radio"/>	<input type="radio"/>
✎ 10.06	3rd Output Frequency (Mid-point frequency)	0136	Read only	<input type="radio"/>	<input type="radio"/>	<input type="radio"/>	<input type="radio"/>	<input type="radio"/>
✎ 10.07	3rd Output Voltage (Mid-point voltage)	0137	Read only	<input type="radio"/>	<input type="radio"/>	<input type="radio"/>	<input type="radio"/>	<input type="radio"/>
✎ 10.08	4th Output Frequency (Low Frequency)	0138	Read only	<input type="radio"/>	<input type="radio"/>	<input type="radio"/>	<input type="radio"/>	<input type="radio"/>
✎ 10.09	4th Output Voltage (Low Voltage)	0139	Read only	<input type="radio"/>	<input type="radio"/>	<input type="radio"/>	<input type="radio"/>	<input type="radio"/>
✎ 10.10	Door Open Acceleration Time 1	0408	Read only	<input type="radio"/>	<input type="radio"/>	<input type="radio"/>	<input type="radio"/>	<input type="radio"/>
✎ 10.11	Door Open Deceleration Time 1	0409	Read only	<input type="radio"/>	<input type="radio"/>	<input type="radio"/>	<input type="radio"/>	<input type="radio"/>
✎ 10.12	Door Close Acceleration Time 2	0508	Read only	<input type="radio"/>	<input type="radio"/>	<input type="radio"/>	<input type="radio"/>	<input type="radio"/>
✎ 10.13	Door Close Deceleration Time 2	0509	Read only	<input type="radio"/>	<input type="radio"/>	<input type="radio"/>	<input type="radio"/>	<input type="radio"/>
✎ 10.14	Frequency Testing	0015	Read only	<input type="radio"/>	<input type="radio"/>	<input type="radio"/>	<input type="radio"/>	<input type="radio"/>
✎ 10.15	Door Open Time by Initial Speed	0402	Read only	<input type="radio"/>	<input type="radio"/>	<input type="radio"/>	<input type="radio"/>	<input type="radio"/>
✎ 10.16	Door Open by Initial Speed	0400	Read only	<input type="radio"/>	<input type="radio"/>	<input type="radio"/>	<input type="radio"/>	<input type="radio"/>
✎ 10.17	Door Open High Speed	0403	Read only	<input type="radio"/>	<input type="radio"/>	<input type="radio"/>	<input type="radio"/>	<input type="radio"/>
✎ 10.18	Door Open Final Speed	0405	Read only	<input type="radio"/>	<input type="radio"/>	<input type="radio"/>	<input type="radio"/>	<input type="radio"/>
✎ 10.19	Door Open Holding Torque Level	0410	Read only	<input type="radio"/>	<input type="radio"/>	<input type="radio"/>	<input type="radio"/>	<input type="radio"/>
✎ 10.20	Door Open Holding Torque	0411	Read only	<input type="radio"/>	<input type="radio"/>	<input type="radio"/>	<input type="radio"/>	<input type="radio"/>
✎ 10.21	Door Close High Speed	0503	Read only	<input type="radio"/>	<input type="radio"/>	<input type="radio"/>	<input type="radio"/>	<input type="radio"/>
✎ 10.22	Door Close Final Speed	0505	Read only	<input type="radio"/>	<input type="radio"/>	<input type="radio"/>	<input type="radio"/>	<input type="radio"/>

Parameter	Explanation	Settings	Factory Setting	VF	VFP	SVC	FOC	FOC
↗ 10.23	Door Close Holding Torque Level	0510	Read only	<input type="radio"/>	<input type="radio"/>	<input type="radio"/>	<input type="radio"/>	<input type="radio"/>
↗ 10.24	Door Close Holding Torque	0511	Read only	<input type="radio"/>	<input type="radio"/>	<input type="radio"/>	<input type="radio"/>	<input type="radio"/>
↗ 10.25	Multi-function Input Terminal Direction	0207	Read only	<input type="radio"/>	<input type="radio"/>	<input type="radio"/>	<input type="radio"/>	<input type="radio"/>
↗ 10.26	Multi-function Input 1	0201	Read only	<input type="radio"/>	<input type="radio"/>	<input type="radio"/>	<input type="radio"/>	<input type="radio"/>
↗ 10.27	Multi-function Input 2	0202	Read only	<input type="radio"/>	<input type="radio"/>	<input type="radio"/>	<input type="radio"/>	<input type="radio"/>
↗ 10.28	Multi-function Input 3	0203	Read only	<input type="radio"/>	<input type="radio"/>	<input type="radio"/>	<input type="radio"/>	<input type="radio"/>
↗ 10.29	Multi-function Input 4	0204	Read only	<input type="radio"/>	<input type="radio"/>	<input type="radio"/>	<input type="radio"/>	<input type="radio"/>
↗ 10.30	Multi-function Output RY1	0208	Read only	<input type="radio"/>	<input type="radio"/>	<input type="radio"/>	<input type="radio"/>	<input type="radio"/>
↗ 10.31	Multi-function Output RY2	0209	Read only	<input type="radio"/>	<input type="radio"/>	<input type="radio"/>	<input type="radio"/>	<input type="radio"/>

11 View User-defined Parameters

✎ This parameter can be set during operation.

Parameter	Explanation	Settings	Factory Setting	VF	VFP	SVC	FOC	FOC
11.00 ~ 11.31	View User-defined Parameters	Pr. 00.00~09.05	-	<input type="radio"/>	<input type="radio"/>	<input type="radio"/>	<input type="radio"/>	<input type="radio"/>

4-2 Description of Parameter Settings

00 System Parameter

⚡ This parameter can be set during operation.

0000

Identity Code of AC Motor Drive

Control mode **VF VFPG SVC FOC PG FOC PM**

Factory setting: Read only

Settings 0:200w

1:400w

0001

Rated Current Display of AC Motor Drive

Control mode **VF VFPG SVC FOC PG FOC PM**

Factory setting: Read only

Settings 0:1.50A

0:2.50A

📖 Pr. 00-00 displays the identity code of the AC motor drive. The capacity, rated current, rated voltage and the max. carrier frequency relate to the identity code. Users can use the following table to check how the rated current, rated voltage and max. carrier frequency of the AC motor drive corresponds to the identity code.

📖 Pr.00-01 displays the rated current of the AC motor drive. By reading this parameter the user can check if the AC motor drive is correct.

0002

Parameter Reset

Control mode **VF VFPG SVC FOC PG FOC PM**

Factory setting: 0

Settings 0: No function

1: Parameters locked

8: Keypad locked

10: All parameters are reset to factory setting (33.3Hz, 230V)

📖 When it is set to 1, all parameters are read only except Pr.00-00~00-07 and it can be used with password setting for password protection.

📖 When Pr.00-02=10, all parameters are reset to factory setting. If password lock was used, please unlock first. After Pr.00-02 set to 10, password will also be cleared and reset to factory setting.

📖 When Pr.00-02=08, the digital keypad will be locked and only Pr.00-02, Pr.00-07 can be set.

⚡

0003

Start-up Display Selection

Control mode **VF VFPG SVC FOC PG FOC PM**

Factory setting: 0

Settings 0: Display the frequency command value (F)

1: Display the actual output frequency (H)

2: Display the content of user-defined unit (U)

3: Display the output current (A)

📖 This parameter determines the start-up display page after power is applied to the drive.

⚡

0004

Content of Multi Function Display

Control mode **VF VFPG SVC FOC PG FOC PM**

Factory setting: 2

Settings 0: Display output current (A)

1: Display actual frequency (Hz)

2: Display DC-BUS voltage (U)

3: Display output voltage(E)

4: Display power factor angle (n.)

- 5: Display output power (kW)
- 6: Display motor angle speed (HU)
- 7: Display the drive's estimated output torque (kg-m)
- 8: Display PG pulse input position
- 9: Display the electrical angle
- 10: Display IGBT temperature(oC)
- 11: Display digital input ON/OFF status
- 12: Display digital output ON/OFF status
- 13: Display current multi-step speed
- 14: Display the corresponding CPU pin status of digital input
- 15: Display the corresponding CPU pin status of digital input
- 16: Actual output voltage when malfunction
- 17: Actual DC-BUS voltage when malfunction
- 18: Actual output frequency when malfunction
- 19: Actual output current when malfunction
- 20: Actual frequency command when malfunction
- 21: Door width in % or step speed
- 22: Door width(pulse)
- 23: Over modulation indication

When Pr.00-03 =2, this parameter is used to display the content user choose to display.

※Description to function 09

$$\left[\left(\frac{\text{rpm}}{60} \times \text{PPR}\right) / 1000\right] \times 10 = \text{Pulse} / 10\text{ms}$$

rpm= motor speed; PPR= (Encoder) pulse number per turn; 1000 (1sec= 1000ms); 10: encoder pulses per10ms

On this page, press to display the content of Pr.00.04 (setting 0~23) accordingly.

0005	Software version
Control mode	VF VFPG SVC FOC PG FOC PM Factory setting: #. ##
	Settings Read only (Different versions will display differently)
0006	Password Input
Control mode	VF VFPG SVC FOC PG FOC PM Factory setting: 0
	Settings 0~9999 0~2: times of wrong password
0007	Password Set
Control mode	VF VFPG SVC FOC PG FOC PM Factory setting: 0
	Settings 0~9999 0: No password set or successful input in Pr.00-07 1: Password has been set

The function of this parameter is to input the password that is set in Pr.0-08. Input the correct password here to enable changing parameters. You are limited to a maximum of 3 attempts. After 3 consecutive failed attempts, a blinking "PcdE" will show up to force the user to restart the AC motor drive in order to try again to input the correct password.

To set a password to protect your parameter settings.

If the display shows 00, no password is set or password has been correctly entered in Pr.0-07. All parameters can then be changed, including Pr.0-08.

The first time you can set a password directly. After successful setting of password the display will show 01.

Be sure to record the password for later use.

To cancel the parameter lock, set the parameter to 00 after inputting correct password into Pr. 0-07.
The password consists of min. 1 digit and max. 4 digits.

How to make the password valid again after decoding by Pr.0-07:

Method 1: Re-input original password into Pr.0-08 (Or you can enter a new password if you want to use a new one).

Method 2: After rebooting, password function will be recovered

Method 3: Input any number or character in Pr.00-07, but not password. (The display screen will show END whether the password entered in Pr.00-07 is accurate or not.)

Password Decode Flow Chart

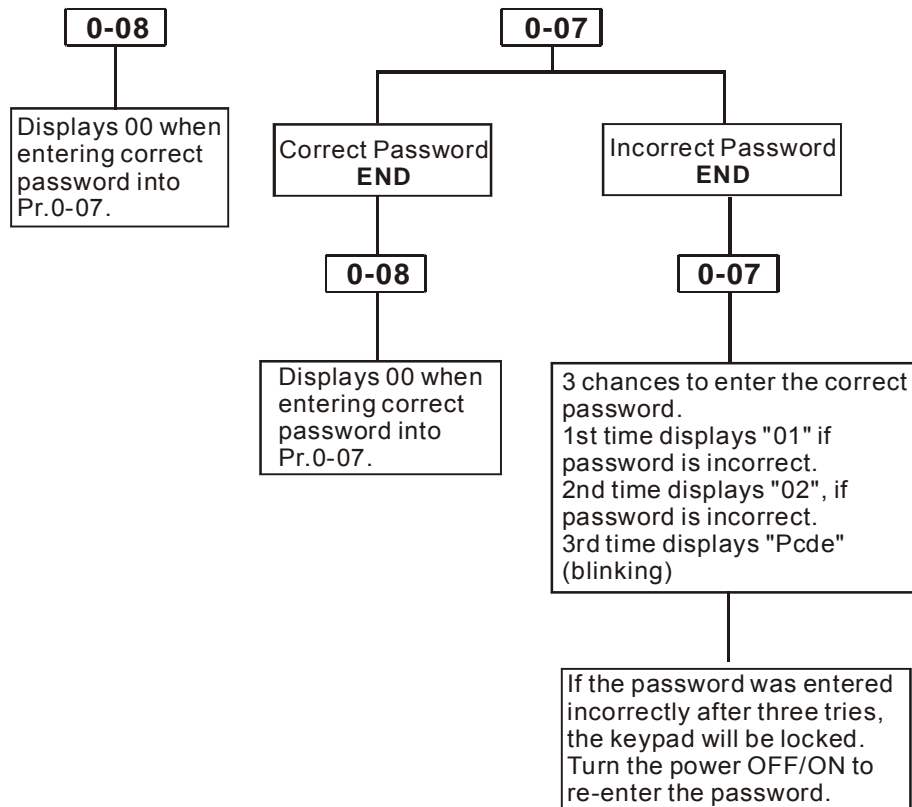

Control Method

Control mode **VF VFPG SVC FOCPG FOCPM**

Factory setting: 0

- Settings
- 0: V/f control
 - 1: V/f Control + Encoder (VFPG)
 - 2: Sensorless vector control (SVC)
 - 3: FOC vector control + Encoder (FOCPG)
 - 8: FOC PM control (FOCPM)

This parameter is used to select the control mode of AC motor drives.

0: V/f control: user can design proportion of V/f as required and can control multiple motors simultaneously.

1: V/f control + Encoder (VFPG): user can use optional PG card with encoder for the closed-loop speed control.

2: Sensorless vector control (SVC): get the optimal control by the auto-tuning of motor parameters.

3: FOC vector control+ encoder (FOCPG): besides torque increases, the speed control will be more accurate (1:1000).

4: FOC PM control + encoder (FOCPM): besides torque increases, the speed control will be more accurate (1:1000).



Door Control Mode

Control mode **VF VFPG SVC FOC PG FOC PM**

Factory setting: 3

- Settings
- 0: Distance control mode
 - 1: Reserved
 - 2: Multi-step speed control mode
 - 3: Speed control mode

0: Distance control mode

Set encoder PG pulses accurately to ensure precise door width estimation. Door width is measured and stored by Auto-tuning. It operates the door for speed switch and completed position by counting the PG pulses. In this mode, position function will be executed whenever power again and operates with low speed to the 0% or 100% door width by the operation direction.

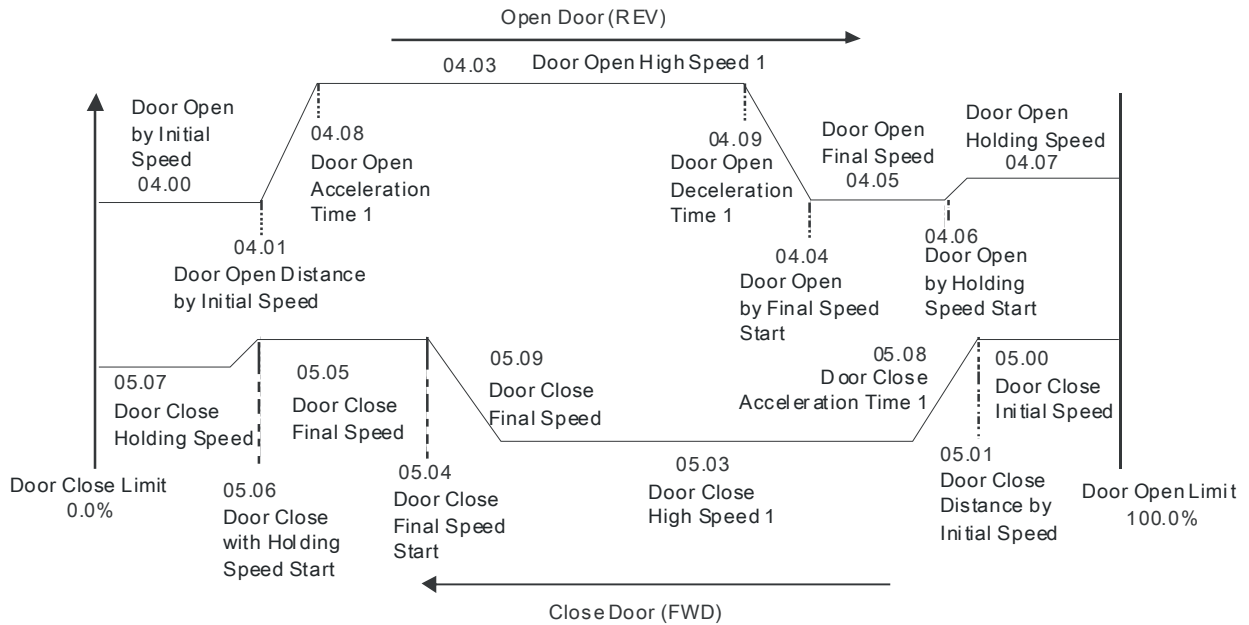

2: Multi-step control mode

The drive is controlled by Sensorless control. For operating the door, it uses three multi-input (level trigger) and operation direction (FWD/REV) to deal with speed switch and limit switch to deal with completed position. (4th logic signal: open: 0; close: 1).

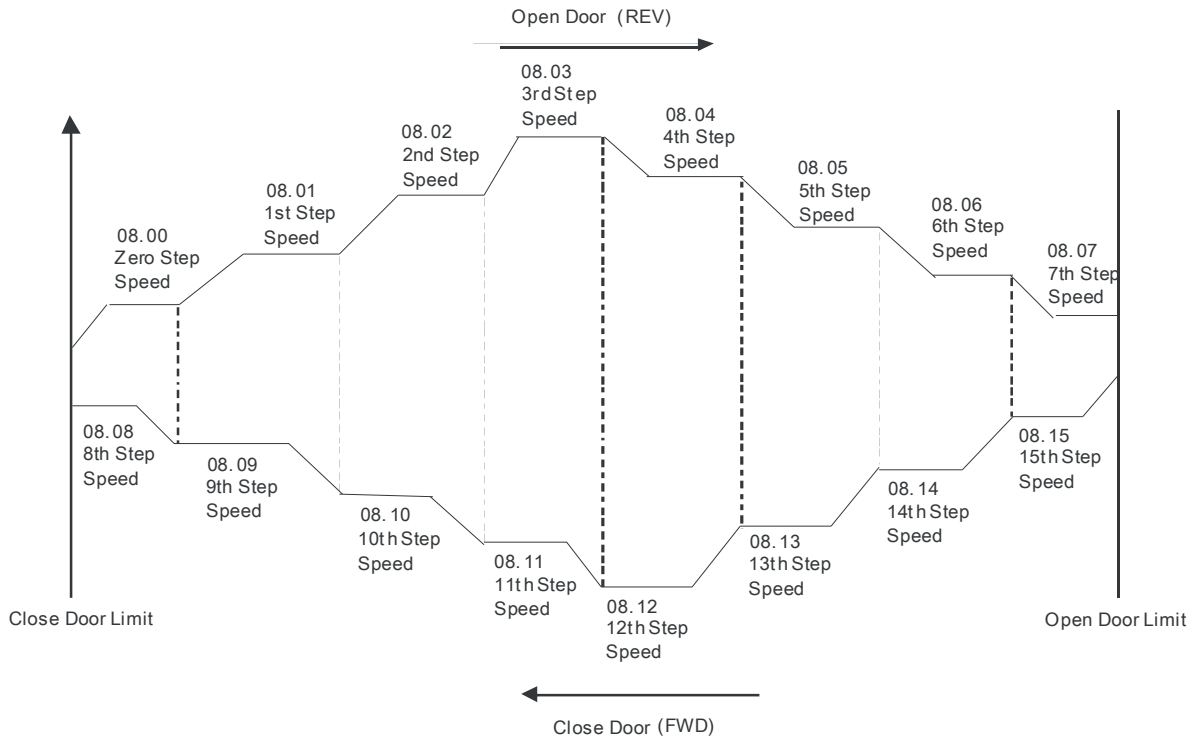

3: Speed Control mode

For operating the door, it switches speed by external signal and uses limit switch to deal with completed position. The signals must be edge trigger. In this mode, it needs to run the door to the close complete position after power on again or AC motor drive stops.

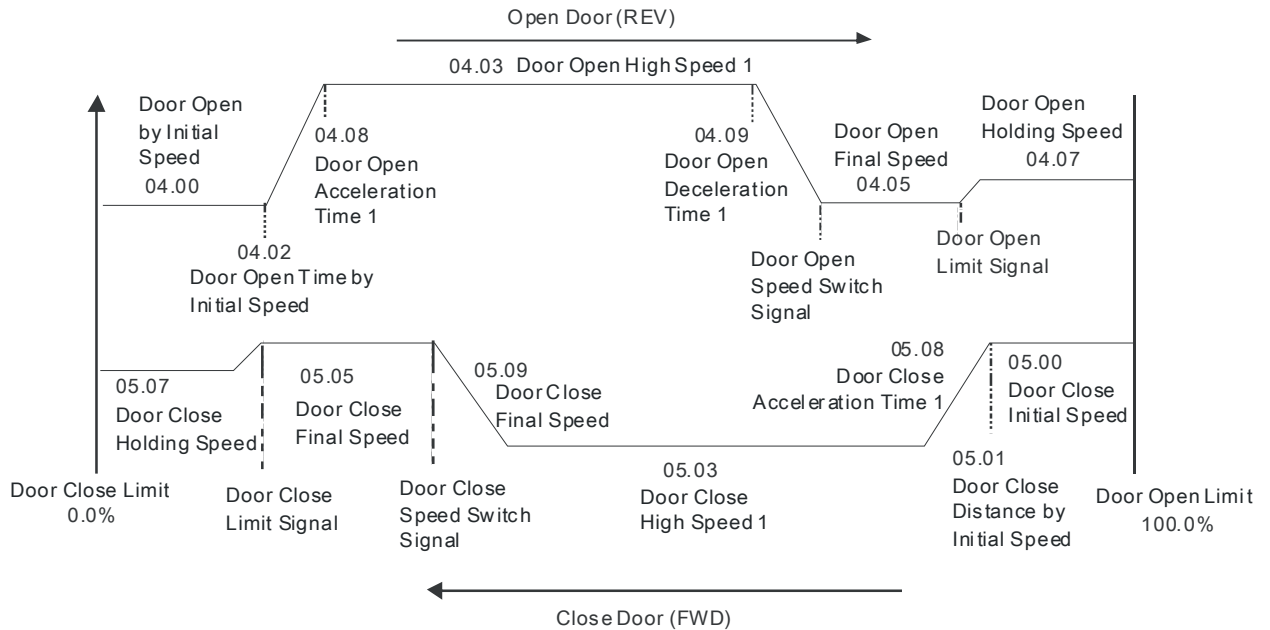

00.10 Output Direction
 Control mode **VF VFPG SVC FOC PG FOC PM** Factory setting: 0
 Settings 0: Runs in same direction as setting
 1: Runs in different direction than setting

00.11 PWM Carrier Frequency Selection
 Control mode **VF VFPG SVC FOC PG FOC PM** Factory setting: 10
 Settings 2~15kHz

This parameter determines the PWM carrier frequency of the AC motor drive.

Carrier Frequency	Acoustic Noise	Electromagnetic Noise or leakage current	Heat Dissipation	Current Wave
1kHz	Significant	Minimal	Minimal	Minimal
8kHz	↕	↕	↕	↕
15kHz				

From the table, we see that the PWM carrier frequency has a significant influence on the electromagnetic noise, AC motor drive heat dissipation, and motor acoustic noise. If noises from ambient environment is greater than motor noise, lower PWM carrier frequency will help to lower the temperature of AC motor drive. When PWM carrier frequency is high, though the drive will operate more quietly, but wiring and interference may have problem.

00.12 Auto Voltage Regulation (AVR) Function

Control mode **VF VFPG SVC FOC PG FOC PM** Factory setting: 0

- Settings 0: Enable AVR
1: Disable AVR
2: Disable AVR when deceleration stop

The rated voltage of the motor is usually AC220V/200V 60Hz/50Hz and the input voltage of the AC motor drive may vary between 180V to 264 VAC 50Hz/60Hz. Therefore, when the AC motor drive is used without AVR function, the output voltage will be the same as the input voltage. When the motor runs at voltages exceeding the rated voltage with 12% - 20%, its lifetime will be shorter and it can be damaged due to higher temperature, failing insulation and unstable torque output.

AVR function automatically regulates the AC motor drive output voltage to the Maximum Output Voltage (Pr.1-02). For instance, if Pr.1-02 is set at 200 VAC and the input voltage is at 200V to 264VAC, then the Maximum Output Voltage will automatically be reduced to a maximum of 200 VAC.

When motor stops with deceleration, it will shorten deceleration time. When setting this parameter to 02 with auto acceleration/deceleration, it will offer a quicker deceleration.

00.13 Source of the Master Frequency Command

Control mode **VF VFPG SVC FOC PG FOC PM** Factory setting: 1

- Settings 0: by digital keypad input
1: by external terminal
2: by RS-485 serial communication

This parameter is used to set the source of the operation command.

00.14 Demo Mode

Control mode **VF VFPG SVC FOC PG FOC PM** Factory setting: 0

- Settings 0: Disable
1: Display demo action

00.15 Frequency Testing Command

Control mode **VF VFPG SVC FOC PG FOC PM** Factory setting: 0

- Settings 0~120.00Hz

When Pr.00-15 is not 0, door will move in testing frequency, other commands to door will stop.

01 Motor Parameters

✎ This parameter can be set during operation.

Motor Auto Tuning (PM)

Control mode

FOCPM

Factory setting: 0

- Settings
- 0: No function
 - 1: Auto-tuning for PM motor parameters (brake locked)
 - 2: Auto-tuning for PG offset angle without load (Pr.01.09)
 - 3: Auto-tuning for PG offset angle with load (Pr.01.09)

When Pr.01-00 = 2, auto-tune for PG offset angle. Please follow the following 3 rules:

1. Unload before Auto-tuning begins.
2. If the brake is control by AC motor drive, the drive can complete tuning process after wiring and brake control parameters are set.
3. If the brake is control by host controller, maker sure brake is at release status when tuning.

When Pr.01-00=3, auto-tuning for PG offset angle. Please follow the following 3 rules:

1. Tuning with load or unload are both allow.
2. When the brake is control by the AC motor drive, after wiring and braking parameters are set up, the drive will execute Tuning following the settings.
3. When the brake is control by the host controller, make sure the brake is released before execute Tuning.
4. Make sure Pr.03-02 (Encoder Input Type) is correct; a wrong setting would cause Pr.01-09 (PG offset angle) measurement error.

When Pr.01-00=1, begins auto-tuning for PM motor by press the **【Run】** key. After auto-tuning process is completed, the measured value will automatically be written into Pr. 01.05, Pr.01.07 (Rs ∙ Lq) and Pr.01.08 (Back EMF).

AUTO-Tuning Process (static rolling) :

1. Make sure the drive is properly installed and all parameter settings are set to the factory setting.
2. Motor: input accurate motor value into Pr.01.01, 01.02, 01.03, 01.04 and adjust the accel. /decel. time according to your motor capacity.
3. Set Pr.01-00=1 and press the "RUN" key on the digital keypad. The motor should now begin auto-tuning. (Note: It is important to fix the motor stably to prevent shaking.)
4. When auto-tuning is complete, check if measured values are written into Pr.01.05 and 01.07.

NOTE

- The input rated speed can not be greater than or equal to 120f/p.
- When auto-tuning is in process, an "Auto-tuning" message will show on the digital keypad. Once the process is complete, the "Auto-tuning" message will be cleared and the measured values will be written into Pr.01-09.
- When auto-tuning is in process, if an error occurs or the drive is stopped manually, an "Auto Tuning Err" message will appear on the digital keypad and it indicates auto-tuning failure, please check if the wirings of the drive are proper. When "PG Fbk Error" occurs, please reset Pr.03-02 (if it is originally set to 1, change it to 2). When "PG Fbk Loss" occurs, please check if the Z phase pulse feedback is normal.

0101

Full-load Current of motor (PM)

Control mode

FOCPM

Unit: Amper

Factory setting: 1.00

Settings (40~120%)*00.01 Amps

This value should be set according to the rated frequency of the motor as indicated on the motor nameplate. The factory setting is 90% X rated current.

Example: If rated current for 400W model is 2.5A. The current range for user will be 2.0~3.0A.

(2.5*40%=1.0; 2.5*120%=3.0)

0102

Rated Power of Motor (PM)

Control mode

FOCPM

Factory setting: 0.06

Settings 0.00~655.35 kW

This parameter sets motor's rated power. Factory setting will be the drive's power.

0103

Rated Speed of PM Motor (rpm)

Control mode

FOCPM

Factory setting: 250

Settings 0~65535

This parameter sets motor's rated speed and it must be set according to the specification shown on the nameplate.

0104

Number of Motor Poles (PM)

Control mode

FOCPM

Factory setting: 16

Settings 2~96

This parameter sets number of motor poles (odd value is invalid).

0105

Rs of Motor parameter (PM)

Control mode

FOCPM

Factory setting: 13.900

Settings 0.0~655.35Ω

0106

Ld of Motor Parameter (PM)

Control mode

FOCPM

Factory setting: 169.4

Settings 0.0~6553.5mH

0107

Lq of Motor Parameter (PM)

Control mode

FOCPM

Factory setting: 169.4

Settings 0.0~6553.5mH

0108

Back Electromotive Force (PM)

Control mode

FOCPM

Factory setting: 0.0

Settings 0.0~6553.5Vrms

This parameter is used to set back electromotive force (phase-phase RMS value) when the motor is operated in the rated speed.

It can get RMS value by Pr.01-00=1 (Motor Auto Tuning)

0109

PG Offset Angle (PM)

Control mode

FOCPM

Factory setting: 360.0

Settings 0.0~360.0°

This parameter is to measure the PG offset angle of PM motor.

0110

Magnetic Pole Re-orientation (PM)

Control mode

FOCPM

Factory setting: 0

- Settings 0: No function
1: Reset magnetic pole position

- This function is used to search magnetic pole position and is only available on permanent magnet motor.
- When encoder origin-adjustment function (Pr.01-09= 360.0) is not available, the motor operation efficiency can only achieve up to 86% of its best efficiency. In this case, if user needs to improve the operation efficiency, reapply power or set Pr.01-10=1 to measure magnetic pole position again.

0111

Motor Auto Tuning (IM)

Control mode

SVC FOC PG

Factory setting: 0

- Settings 0: No function
1: Rolling test
2: Static test
3: Reserved

- Set Pr.01-11 to 1 or 2, Press **【Run】** to begin auto tuning. The measured value will be written into Pr.1-17 to Pr.01-20 (Rs, Rr, Lm, Lx, no-load current).
- AUTO-Tuning Process (rolling test):
 - Make sure that all the parameters are set to factory settings and the motor wiring is correct.
 - Make sure the motor has no-load before executing auto-tuning and the shaft is not connected to any belt or gear motor. It is recommended to perform auto-tuning in static test if the motor can't separate from the load.
 -

	Pr. of Motor
Motor Rated Frequency	01-32
Motor Rated Voltage	01-33
Motor Full-load Current	01-11
Motor Rated Power	01-13
Motor Rated Speed	01-14
Motor Pole Numbers	01-15

- Set Pr.01-11=1 and press **【Run】**, the drive will begin auto-tuning. Please be aware of the motor that it starts spinning as **【Run】** is pressed.
- When auto-tuning is completed, please check if the measured values are written into Pr.01-16 ~01-20).
- Mechanical equivalent circuit

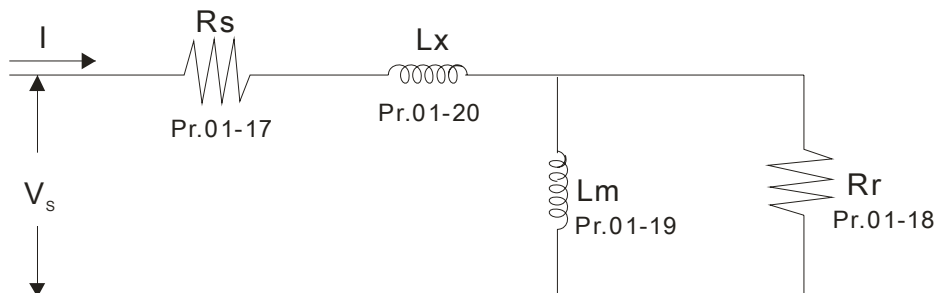

※ When Pr.01-11 is set to 2 (static test), user needs to write no-load current value of motor into Pr.01-16.

 **NOTE**

- ☑ In torque/vector control mode, it is not recommended to have motors run in parallel.
- ☑ It is not recommended to use torque/vector control mode if motor rated power exceeds the rated power of the AC motor drive.
- ☑ The no-load current is usually 20~50% X rated current.
- ☑ The rated speed can not be greater than or equal to $120f/p$ (f =rated frequency Pr.01-32; P : number of motor poles Pr.01-15).

0112 Full-load Current of Motor (IM)

Control mode **VF VFPG SVC FOC PG** Unit: Amper
Factory setting: 1.00
Settings (40~120%)*00.01 Amps

 This value should be set according to the rated frequency of the motor as indicated on the motor nameplate. The factory setting is 90% X rated current.

Example: If rated current for 400W model is 2.5A. The current range for user will be 2.0~3.0A.

$(2.5 \times 40\% = 1.0 \quad 2.5 \times 120\% = 3.0)$

0113 Rated power of Motor (IM)

Control mode **SVC FOC PG** Factory setting: 0.06
Settings 0.00~655.35 kW

 This parameter sets motor's rated power. Factory setting will be the drive's power.

0114 Rated speed of IM Motor (rpm)

Control mode **VFPG SVC FOC PG** Factory setting: 250
Settings 0~65535

 This parameter sets motor's rated speed and it must be set according to the specification shown on the nameplate.

0115 Number of Motor Poles (IM)

Control mode **VF VFPG SVC FOC PG** Factory setting: 16
Settings 2~96

 This parameter sets number of motor poles (odd value is invalid).

0116 No-load Current of Motor (IM)

Control mode **VFPG SVC FOC PG** Factory setting: #. ##
Settings 00~ Pr.01.12 factory setting

 Factory setting of the drive's rated current is 40%.

0117 Rs of Motor (IM)

Control mode **SVC FOC PG** Factory setting: 0.000
Settings 0.000~65.535mΩ

0118 Rr of Motor (IM)

Control mode **SVC FOC PG** Factory setting: 0.000
Settings 0.0~65.535mH

0119 Lm of Motor (IM)

Control mode **SVC FOC PG** Factory setting: 0.0
Settings 0.0~6553.5mH

0120 Lx of Motor (IM)

Control mode **SVC FOC PG** Factory setting: 0.0

Settings 0.0~6553.5mH

0121 Torque Compensation Time Constant

Control mode **SVC** Factory setting: 0.020

Settings 0.001~10.000sec

0122 Slip Compensation Time Constant

Control mode **SVC** Factory setting: 0.100

Settings 0.001~10.000sec

- The slip compensation response time can be set by Pr.01-21 and Pr.01-22 and maximum up to 10 sec.
- When Pr.01-21 and Pr.01-22 are set to 10 sec, it is the slowest response time the drive supports. If the response time is set too quick, the system may be unstable.

0123 Torque Compensation Gain

Control mode **VF VFPG** Factory setting: 0

Settings 0~10

- This parameter sets the amount of additional voltage output during operation to get greater torque.

0124 Slip Compensation Gain

Control mode **VF VFPG SVC** Factory setting: 0.00

Settings 0.00~10.00

- When AC motor drive drives the induction motor, slips increase as load increase. This parameter can be used to set compensation frequency and reduce the slip to close the synchronous speed when the motor runs in the rated current to raise the drive accuracy. When drive's output current is greater than the motor current at no-load, the drive will compensate the frequency according to the setting in this parameter. When actual speed is slower than expected, increase the value in Pr.01-24; if actual speed is faster than expected, lower the value in Pr.01-24.
- This parameter is valid for SVC mode only.

0125 Slip Deviation Level

Control mode **VFPG SVC FOC PG** Factory setting: 0

Settings 00~1000% (0:Disable)

0126 Detection Time of Slip Deviation

Control mode **VFPG SVC FOC PG** Factory setting: 1.0

Settings 0.0~10.0sec

0127 Over Slip Treatment

Control mode **VFPG SVC FOC PG** Factory setting: 0

Settings 0: Warn and keep operation
1: Warn and ramp to stop
2: Warn and coast to stop

- Pr.01-25 to Pr.01-27 is used to set the allowable slip level/time and over slip treatment when the drive is running.

0128 Hunting Gain

Control mode **VF VFPG SVC** Factory setting: 2000

Settings 0~10000 (0: No action)

 The motor will have current wave motion in some specific area. It can improve this situation by setting this parameter. (When it is high frequency or run with PG, it can be set to 0. when the current wave motion happens in the low frequency, please increase the value in Pr.01-28.)

0129 Accumulative Motor Operation Time (Min.)

Control mode **VF VFPG SVC FOC PG** Factory setting: 0
Settings 0~1439

0130 Accumulative Motor Operation Time (day)

Control mode **VF VFPG SVC FOC PG** Factory setting: 0
Settings 0~65535

 This parameter records the motor running time. When Pr.01-29 and Pr.01-30 are set to 00, it clears the setting to 0. Operation time will not be recorded if it is shorter than 60 sec.

0131 Maximum Output Frequency

Control mode **VF VFPG SVC FOC PG FOC PM** Factory setting: 50
Settings 10.00~120.00Hz

 This parameter determines the AC motor drive's Maximum Output Frequency. All the AC motor drive frequency command sources (analog inputs 0 to +10V, 4 to 20mA, 0 to 20mA and ±10V) are scaled to correspond to the output frequency range.

0132 Output Frequency 1(Base frequency /Motor rated frequency)

Control mode **VF VFPG SVC FOC PG FOC PM** Factory setting: 50
Settings 0.00~120.00Hz

 This value should be set according to the rated frequency of the motor as indicated on the motor nameplate. If the motor is 60Hz, the setting should be 60Hz. If the motor is 50Hz, it should be set to 50Hz.

0133 Output Voltage 1(Base voltage/Motor rated voltage)

Control mode **VF VFPG SVC FOC PG FOC PM** Factory setting: 220.0
Settings 0.0V~240.0V

 This value should be set according to the rated voltage of the motor as indicated on the motor nameplate. If the motor is 220V, the setting should be 220.0. If the motor is 200V, it should be set to 200.0.

 There are many motor types in the market and the power system for each country is also difference. The economic and convenience method to solve this problem is to install the AC motor drive. There is no problem to use with the different voltage and frequency and also can amplify the original characteristic and life of the motor.

0134 Output Frequency 2

Control mode **VF VFPG** Factory setting: 0.50
Settings 0.00~120.00Hz

 **0135** Output Voltage 2

Control mode **VF VFPG** Factory setting: 5.0
Settings 0.0V~240.0V

0136 Output Frequency 3

Control mode **VF VFPG** Factory setting: 0.50
Settings 0.00~120.00Hz

↗ **0137** Output Voltage 3

Control mode **VF VFPG** Factory setting: 5.0
Settings 0.0V~240.0V

0138 Output Frequency 4

Control mode **VF VFPG SVC FOC PG** Factory setting: 0.00
Settings 0.00~120.00Hz

↗ **0139** Output Voltage 4

Control mode **VF VFPG** Factory setting: 0.0
Settings 0.0V~240.0V

📖 V/f curve setting is usually set by the motor's allowable loading characteristics. Pay special attention to the motor's heat dissipation, dynamic balance, and bearing lubricity, if the loading characteristics exceed the loading limit of the motor.

📖 The frequency setting of V/F curve must be set according to this rule, Pr. 01.32≥01.34≥01.36≥01.38. There is no limit for the voltage setting, but a high voltage at low frequency may cause motor damage, overheat, and stall prevention or over-current protection. Therefore, please use the low voltage at the low frequency to prevent motor damage.

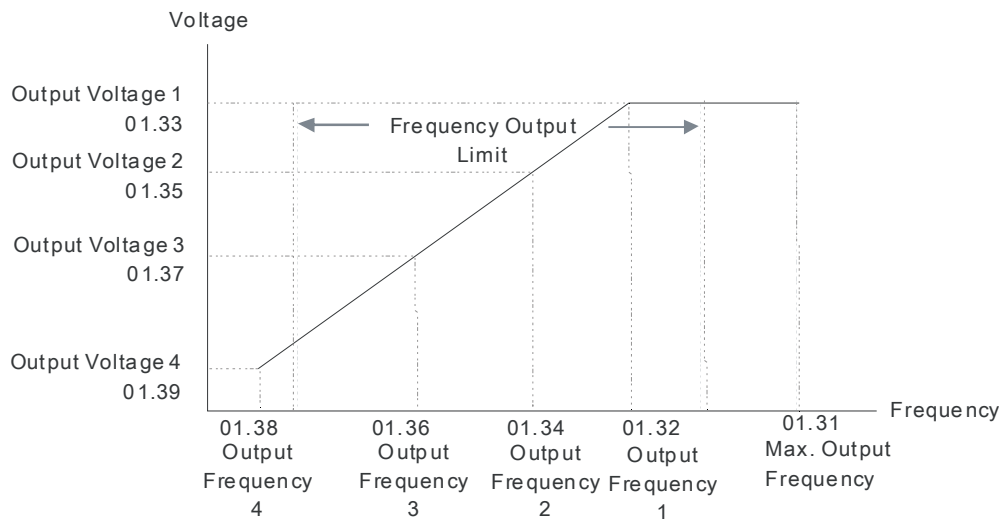

V/F Curve

02 Input/Output Parameters

↗ This parameter can be set during operation.

0200 2-wire/3-wire Operation Control

Control mode **VF VFPG SVC FOC PG FOC PM**

Factory setting: 0

- Settings
- 0 FWD/STOP
 - 1 FWD/STOP, REV/STOP (Line Start Lockout)
 - 2 RUN/STOP, REV/FWD
 - 3 RUN/STOP, REV/FWD (Line Start Lockout)

📖 When line start lockout is enabled, the drive will not run once applying the power. The Line Start Lockout feature doesn't guarantee the motor will never start under this condition. It is possible the motor may be set in motion by a malfunctioning switch. This parameter sets the drive's lock when power is applied.

This parameter sets three different control modes by external control:

Pr.02-00	Control Circuits of the External Terminal
Setting: 0 · 1 2-wire operation control (1) FWD/STOP REV/STOP	
Setting: 2 · 3 2-wire operation control (1) RUN/STOP REV/FWD	

0201 Multi-Function Input 1 (MI1)

Factory setting: 14

0202 Multi-Function Input 2 (MI2)

Factory setting: 15

0203 Multi-Function Input 3 (MI3)

Factory setting: 16

0204 Multi-Function Input 4 (MI4)

Factory setting: 17

0205 Multi-Function Input 5 (MI5)

Factory setting: 0

Settings	Control mode	VF	VFPG	SVC	FOCPG	FOCPM
0: No function		<input type="radio"/>	<input type="radio"/>	<input type="radio"/>	<input type="radio"/>	<input type="radio"/>
1: Multi-step speed command 1		<input type="radio"/>	<input type="radio"/>	<input type="radio"/>	<input type="radio"/>	<input type="radio"/>
2: Multi-step speed command 2		<input type="radio"/>	<input type="radio"/>	<input type="radio"/>	<input type="radio"/>	<input type="radio"/>
3: Multi-step speed command 3		<input type="radio"/>	<input type="radio"/>	<input type="radio"/>	<input type="radio"/>	<input type="radio"/>
4: Multi-step speed command 4		<input type="radio"/>	<input type="radio"/>	<input type="radio"/>	<input type="radio"/>	<input type="radio"/>
5: Fault reset		<input type="radio"/>	<input type="radio"/>	<input type="radio"/>	<input type="radio"/>	<input type="radio"/>
6: Low speed operation		<input type="radio"/>	<input type="radio"/>	<input type="radio"/>	<input type="radio"/>	<input type="radio"/>
7: FWD/REV command for low speed operation		<input type="radio"/>	<input type="radio"/>	<input type="radio"/>	<input type="radio"/>	<input type="radio"/>

8: 1st, 2nd acceleration/deceleration time selection	<input type="radio"/>	<input type="radio"/>	<input type="radio"/>	<input type="radio"/>	<input type="radio"/>
9: Force stop (NO) input	<input type="radio"/>	<input type="radio"/>	<input type="radio"/>	<input type="radio"/>	<input type="radio"/>
10: Demo mode	<input type="radio"/>	<input type="radio"/>	<input type="radio"/>	<input type="radio"/>	<input type="radio"/>
11: Emergency stop (NO) input	<input type="radio"/>	<input type="radio"/>	<input type="radio"/>	<input type="radio"/>	<input type="radio"/>
12: Source of operation command (Keypad/External terminals)	<input type="radio"/>	<input type="radio"/>	<input type="radio"/>	<input type="radio"/>	<input type="radio"/>
13: Parameter lock enable (NC)	<input type="radio"/>	<input type="radio"/>	<input type="radio"/>	<input type="radio"/>	<input type="radio"/>
14: Door open complete signal	<input type="radio"/>	<input type="radio"/>	<input type="radio"/>	<input type="radio"/>	<input type="radio"/>
15: Door close complete signal	<input type="radio"/>	<input type="radio"/>	<input type="radio"/>	<input type="radio"/>	<input type="radio"/>
16: Door open speed switch signal	<input type="radio"/>	<input type="radio"/>	<input type="radio"/>	<input type="radio"/>	<input type="radio"/>
17: Door close speed switch signal	<input type="radio"/>	<input type="radio"/>	<input type="radio"/>	<input type="radio"/>	<input type="radio"/>
18: Open allowance signal	<input type="radio"/>	<input type="radio"/>	<input type="radio"/>	<input type="radio"/>	<input type="radio"/>
19: Screen signal input	<input type="radio"/>	<input type="radio"/>	<input type="radio"/>	<input type="radio"/>	<input type="radio"/>
20: Door curve signal input for 2nd set door open/close	<input type="radio"/>	<input type="radio"/>	<input type="radio"/>	<input type="radio"/>	<input type="radio"/>
21: Reset signal input	<input type="radio"/>	<input type="radio"/>	<input type="radio"/>	<input type="radio"/>	<input type="radio"/>

 This parameter selects the functions for each multi-function terminal.

Summary of Function Settings:

Settings	Functions	Descriptions
0	No function	Any unused terminals should be programmed to 0 to insure they have no effect on operation.
1	Multi-step speed command 1	When door control mode (Pr.00-09) is set 2 (multi-step speed control), these four inputs can be used for 16 step speed frequencies
2	Multi-step speed command 2	
3	Multi-step speed command 3	
4	Multi-step speed command 4	
5	Fault reset	Reset drive setting after fault is cleared.
6	Low speed operation	Before using this function, please make sure that AC motor drive is stop. At this moment, key "STOP" on the digital keypad is still valid. When this contact is OFF, motor will stop by deceleration time of low speed operation.
7	FWD/REV command for low speed operation	ON: REV OFF: FWD This command will be effective only when external terminal for low speed operation is active.
8	1st, 2nd acceleration/deceleration time selection	When signal is input, the AC motor drive can switch between 1st and 2nd acceleration/deceleration time
9	Force stop (NO) input	This parameter has the same function as the "STOP" command and no error message will be displayed. It does not require a RESET but a new RUN command is needed for the drive to run again.
10	Demo mode	When this setting is enabled, the output frequency of AC motor drive will run by open/close curve repeatedly till this setting is disabled. It will get the best open/close curve by this action.
11	Emergency stop (NO) input	When setting to 11, the Multi-Function Input Terminal can be used to stop the AC motor drive in case of malfunction in the application. It will display "EF". Please "RESET" after the fault has been cleared.
12	Source of operation command (Keypad/External terminals)	ON: Operation command via Ext. Terminals OFF: Operation command via Keypad Pr.00-14 is disabled if this parameter is set to 13.
13	Parameter lock enable (NC)	When this setting is enabled, all parameter reading value will be 00. This setting must be disabled in order to read the parameter content.
14	Door open complete signal	When Pr.06-11 is set to 01 or 03, drive will open the door to the completed position by this signal.

15	Door close complete signal	When Pr.06-11 is set to 02 or 03, drive will close the door to the completed position by this signal.
16	Door open speed switch signal	When door control mode (pr.00-09) is set to 3 speed control mode, this terminal can be used for switching speed.
17	Door close speed switch signal	When door control mode (pr.00-09) is set to 3 speed control mode, this terminal can be used for switching speed.
18	Open allowance signal	When this setting is enabled, it allows opening the door. It also can be used for the signal of door zone.
19	Screen signal input	
20	Door curve signal input for 2nd step door open/close	When this setting is ON, it will run the curve of 2nd step door open/close.
21	Reset signal input	When parameter is set to 21, the drive re-positioning begins.

⚡ **02.06** Digital Terminal Input Debouncing Time (MD-5-13)
Control mode **VF VFPG SVC FOC PG FOC PM** Factory setting: 0.005
Settings 0.001~30.000sec

📖 This parameter is to delay the signals on digital input terminals. 1 unit is 2.5 msec. The delay time is to debounce noisy signals that could cause the digital terminals to malfunction but response time maybe a bit slower.

⚡ **02.07** Digital Input Operation Direction
Control mode **VF VFPG SVC FOC PG FOC PM** Factory setting: 60
Settings 0~65535

- 📖 This parameter is used to set the input signal level.
- 📖 bit 0 is CD terminal, bit 1 is OD terminal and bit 2~bit 6 are MI1~MI5.
- 📖 User can change the terminal status ON/OFF by communicating.

For example, MI1 is set to 1 (multi-step speed command 1), MI2 is set to 2 (multi-step speed command 2). Then the forward + 2nd step speed command=1001(binary) =9 (Decimal). Only need to set Pr.02-07=9 by communication and it can forward with 2nd step speed. It doesn't need to wire any multi-function terminal.

bit6	bit5	bit4	bit3	bit2	bit1	bit0
MI5	MI4	MI3	MI2	MI1	OD	CD

⚡ **02.08** Multi-function Output (Relay1)
Factory setting: 16

⚡ **02.09** Multi-function Output (Relay2)
Factory setting: 17

⚡ **02.10** Multi-function Output (MO1)
Factory setting: 0

⚡ **02.11** Multi-function Output (MO2)
Factory setting: 0

⚡ **02.12** Multi-function Output (MO3)
Factory setting: 0

Settings	Control mode	VF	VFPG	SVC	FOC PG	FOC PM
0: No function		<input type="radio"/>	<input type="radio"/>	<input type="radio"/>	<input type="radio"/>	<input type="radio"/>
1: AC drive in operation		<input type="radio"/>	<input type="radio"/>	<input type="radio"/>	<input type="radio"/>	<input type="radio"/>

2: Zero speed frequency signal (including STOP)	○	○	○	○	○
3: AC drive ready	○	○	○	○	○
4: Low voltage warning(Lv)	○	○	○	○	○
5: Fault indication	○	○	○	○	○
6: Overhead warning (Pr.06.09)	○	○	○	○	○
7: Detection of braking resistor action level	○	○	○	○	○
8: Warning indication	○	○	○	○	○
9: Over voltage warning	○	○	○	○	○
10: FWD command	○	○	○	○	○
11: REV command	○	○	○	○	○
12: Demo Indication	○	○	○	○	○
13: Demo complete	○	○	○	○	○
14: Force stop indication	○	○	○	○	○
15: Emergency stop indication	○	○	○	○	○
16: Door close complete (limit) signal output	○	○	○	○	○
17: Door open complete (limit) signal output	○	○	○	○	○
18: Door Close Error	○	○	○	○	○
19: Position Complete Signal	○	○	○	○	○
20: Position Detection 1(for door close only)	○	○	○	○	○
21: Position Detection 2(for door close only)	○	○	○	○	○
22: Position Detection 3(for door close only))	○	○	○	○	○
23: Position Detection 1(for door open only)	○	○	○	○	○
24: Position Detection 2(for door open only)	○	○	○	○	○
25: Position Detection 3(for door open only)	○	○	○	○	○
26: PG feedback error	○	○	○	○	○

 These parameters can be used for external terminal output

Summary of Function Settings

Settings	Functions	Descriptions
0	No function	MO has no function.
01	AC drive in operation	The drive is ON when it receives voltage or operation command.
2	Zero speed frequency signal (including STOP)	Zero speed output signals (including STOP).
3	AC drive ready	Active when the drive is ON and no abnormality detected or abnormality is cleared.
4	Low voltage warning(Lv)	Active when the detected input voltage is too low.
5	Fault indication	Active when fault occurs.
6	Overhead warning (Pr.06.09)	Active when IGBT or heat sink overheats to prevent OH turn off the drive. When temperature higher than 85°C = ON, lower than <80°C = OFF.
7	Detection of braking resistor action level	Active when drive begins software braking, this signal can be used as brake module VFDB action signal or indicator.
8	Warning indication	Active when warning is detected.
9	Over voltage warning	Active when over-voltage is detected.
10	FWD command	Active when the operation direction is forward.
11	REV command	Active when the operation direction is reverse.
12	Demo Indication	Active when the drive is in demo mode.
13	Demo complete	Active when each time door open/close is complete in demo mode (contact closed for 0.5s only).
14	Force stop indication	Active when force stop is detected.
15	Emergency stop indication	Active when emergency stop is detected.

16	Door close complete (limit) signal output	Active when position mode (Pr.06-11) is set to "no door close limit signal" and the door width is less than Pr.05-06 setting during the door close. Active when position mode (Pr.06-11) is set to door close limit signal allow and one of MI (Pr.02-01~02-05) is set to 15.
17	Door open complete (limit) signal output	Active when position mode (Pr.06-11) is set to "no door close limit signal" and the door width is greater than the setting in Pr.04-06. Active when position mode (Pr.06-11) is set to door close limit signal allow and one of MI (Pr.02-01~02-05) is set to 14.
18	Door close error	Active when door close error. (Includes door reopen and not reopen).
19	Position complete signal	Active when positioning is completed after drive power is on or PGEr. This function is valid when Pr.00-10=00.
20	Position Detection 1(for door close only)	Active when door close width is lower than Pr.06-14 (valid when door close).
21	Position Detection 2(for door close only)	Active when door close width is lower than Pr.06-15 (valid when door close).
22	Position Detection 3(for door close only))	Active when door close width is lower than Pr.06-16 (valid when door close).
23	Position Detection 1(for door open only)	Active when door close width is lower than Pr.06-14 (valid when door open).
24	Position Detection 2(for door open only)	Active when door close width is lower than Pr.06-14 (valid when door open).
25	Position Detection 3(for door open only)	Active when door close width is lower than Pr.06-14 (valid when door open).
26	PG feedback error	Active when PG feedback signal error is detected

02.13 Digital Output Direction

Control mode **VF VFPG SVC FOC PG FOC PM**
Settings 00~65535

Factory setting: 0

This parameter is set via bit setting. If a bit is 1, the corresponding output acts in the opposite way.

Example:

If Pr02-08=1 (operation indication) and Pr.02-13=0, Relay 1 RA-RC is closed when the drive runs and is open when the drive is stopped.

If Pr02-08=1 and Pr02-13=1, Relay 1 RA-RC is open when the drive runs and is closed when the drive is stopped.

02.14 Position Detection Signal 1

Control mode **VF VFPG SVC FOC PG FOC PM**
Settings 0.0~100.0%

Factory setting: 25.0

02.15 Position Detection Signal 2

Control mode **VF VFPG SVC FOC PG FOC PM**
Settings 0.0~100.0%

Factory setting: 12.5

02.16 Position Detection Signal 3

Control mode **VF VFPG SVC FOC PG FOC PM**
Settings 0.0~100.0%

Factory setting: 7.5

When Pr.02-12 (multi-function output terminal) are set to 16~18, it will output a signal once the door is in position that Pr.02-14~02-16 set.

03 Feedback Parameter

✎ This parameter can be set during operation.

0300

Encoder (PG) Signal Type

Control mode **VFPG** **FOCPG** **FOCPM** Factory setting: 7

- Settings 0: No function
1: ABZ
7: PWM pulse

📖 Detection of the magnetic pole: Setting 1: The AC motor drive will output short circuit to detect the position of the magnetic pole. At this moment, the motor will generate a little noise.

📖 Reference table for encoder and tuning

Setting of PG signal type	Encoder (PG) Signal type	Pr.01-00=01	Pr.01-00=03
10.00=1	A, B, Z	Motor will run	Motor will run
10.00=7	PMM	Motor will run	Motor will run

0301

Encoder pulse

Control mode **VFPG** **FOCPG** **FOCPM** Factory setting: 256

Settings 1~25000

📖 A Pulse Generator (PG) or encoder is used as a sensor that provides a feedback signal of the motor speed. This parameter defines the number of pulses for each cycle of the PG control (PPR).

0302

Encoder Input Type Setting

Control mode **VFPG** **FOCPG** **FOCPM** Factory setting: 1

- Settings 0: Disable
1: Phase A leads in a forward run command and phase B leads in a reverse run command

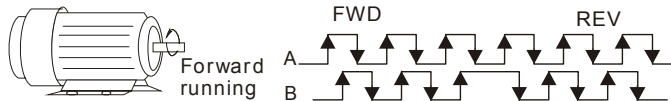

- 2: Phase B leads in a forward run command and phase A leads in a reverse run command

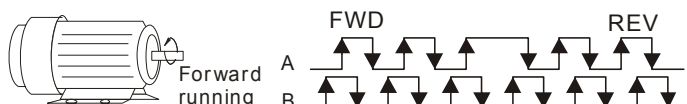

- 3: Phase A is a pulse input and phase B is a direction input. (low input=reverse direction, high input=forward direction)

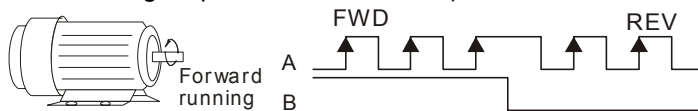

- 4: Phase A is a pulse input and phase B is a direction input. (low input=forward direction, high input=reverse direction)

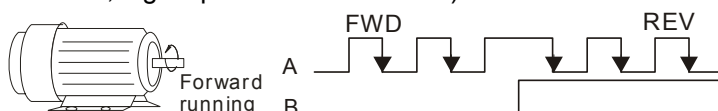

- 5: Single-phase input



📖 It is helpful for the stable control by inputting correct pulse type.

03.03 Encoder Feedback Fault Treatment (PGF1, PGF2)

Control mode **VFPG** **FOCPG** Factory setting: 2

Settings 0: Warn and keep operation
1: Warn and ramp to stop
2: Warn and stop operation

03.04 Detection Time for Encoder Feedback Fault

Control mode **VFPG** **FOCPG** **FOCPM** Factory setting: 1.0

Settings 0.0~10.0sec

When PG loss, encoder signal error, pulse signal setting error or signal error, if time exceeds the detection time for encoder feedback fault (Pr.03-04), the PG signal error will occur. Refer to the Pr.03-03 for encoder feedback fault treatment.

03.05 Encoder Stall Level (PGF3)

Control mode **VFPG** **SVC** **FOCPG** **FOCPM** Factory setting: 115

Settings 0~120% (0: disable)

This parameter determines the maximum encoder feedback signal allowed before a fault occurs. (max. output frequency Pr.01-00 =100%)

03.06 Encoder Stall Detection Time

Control mode **VFPG** **SVC** **FOCPG** **FOCPM** Factory setting: 0.1

Settings 0.0~2.0sec
Encoder feedback error (Max. output frequency Pr.01-31=100%)

03.07 Encoder Slip Range (PGF4)

Control mode **VFPG** **SVC** **FOCPG** **FOCPM** Factory setting: 50

Settings 0~50% (0:disable)
Encoder feedback error (Max. output frequency Pr.01-31=100%)

03.08 Encoder Slip Detection Time

Control mode **VFPG** **SVC** **FOCPG** **FOCPM** Factory setting: 0.5

Settings 0.0~10.0sec
Encoder feedback error (Max. output frequency Pr.01-31=100%)

03.09 Encoder Stall and Slip Error Treatment

Control mode **VFPG** **SVC** **FOCPG** Factory setting: 2

Settings Encoder PG signal feedback error (Max. output frequency Pr.01-31=100%)
0: Warn and keep operation
1: Warn and ramp to stop
2: Warn and coast to stop

When the value of (rotation speed – motor frequency) exceeds Pr.03-07 setting, detection time exceeds Pr.03-08 or motor frequency exceeds Pr.03-05 setting, it will start to accumulate time. If detection time exceeds Pr.10-06, the encoder feedback signal error will occur. Refer to Pr.03-09 encoder stall and slip error treatment.

03.10 Door Width Auto-tuning Frequency

Control mode **VF** **VFPG** **SVC** **FOCPG** **FOCPM** Factory setting: 5.0

Settings 0.10~120.00Hz

This parameter is the frequency of motor when using door width auto-tuning function.

03.11 Door Width Auto-tuning

Control mode **VF** **VFPG** **SVC** **FOCPG** **FOCPM** Factory setting: 0

Settings 0: Disable
1: Enable

The door width will be difference due to its application. For example, the door of the freight elevator is much wider than passenger elevator. Therefore, it needs to have door width auto tuning function to measure the correct door width for the correct position and door open/close. This parameter is suitable for the condition when door control mode is set to distance control mode (Pr.00-10=0).

The procedure for the door width auto-tuning function:

1. Close the door and make sure it reaches its close complete position, and then open the door to measure the door width and close the door again to double check the door width.
2. After door width auto-tuning is complete, the measured value will write into Pr.03-12 and Pr.03-13 automatically.

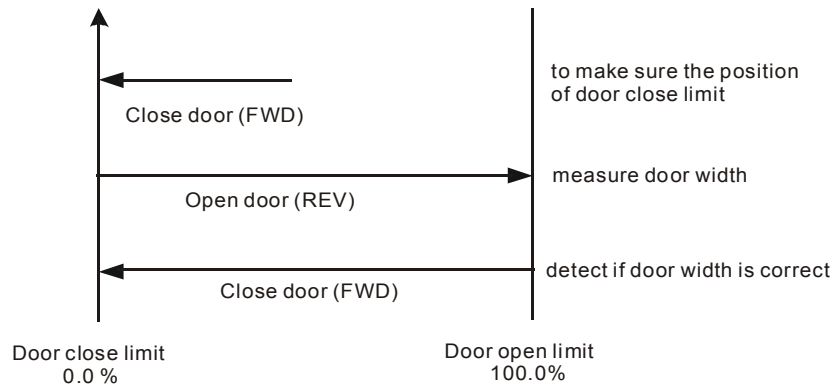

03.12

Door Width Pulses (Unit:1)

Control mode **VF VFPG SVC FOC PG FOC PM**
Settings 1~9999

Factory setting: 8800

03.13

Door Width Pulses (Unit:10000)

Control mode **VF VFPG SVC FOC PG FOC PM**
Settings 0~9999 (Unit:10000)

Factory setting: 0

After door width auto tuning (Pr.03-11=1) is completed, door width pulses will write into Pr.03-12 and Pr.03-13 automatically. User can also manually input door width pulses into Pr.03-12 and Pr.03-13.

04 Door Open Parameters

✎ This parameter can be set during operation.

✎	0400	Door Open by Initial Speed	
	Control mode	VF VFPG SVC FOC PG FOC PM	Factory setting: 2.00
		Settings 0.00~120.0Hz	
✎	0401	Door Open Distance by Initial Speed	
	Control mode	VF VFPG SVC FOC PG FOC PM	Factory setting: 300
		Settings 0~65535 (pulses number)	
✎	0402	Door Open Time by Initial Speed	
	Control mode	VF VFPG SVC FOC PG FOC PM	Factory setting: 1.0
		Settings 0~20.0s	
✎	0403	Door Open High Speed 1	
	Control mode	VF VFPG SVC FOC PG FOC PM	Factory setting: 15.00
		Settings 0.00~120.0Hz	
✎	0404	Door Open by Final Speed Begins	
	Control mode	VF VFPG SVC FOC PG FOC PM	Factory setting: 90.0
		Settings 0.0~100.0% (Door width setting in %)	
✎	0405	Door Open Final Speed	
	Control mode	VF VFPG SVC FOC PG FOC PM	Factory setting: 5.00
		Settings 0.00~120.0Hz	
✎	0406	Door Open by Holding Speed Begins	
	Control mode	VF VFPG SVC FOC PG FOC PM	Factory setting: 95.0
		Settings 0.0~100.0% (Door width setting in %)	
✎	0407	Door Open Holding Speed	
	Control mode	VF VFPG SVC FOC PG FOC PM	Factory setting: 2.00
		Settings 0.00~120.0Hz	
✎	0408	Door Open Acceleration Time 1	
	Control mode	VF VFPG SVC FOC PG FOC PM	Factory setting: 1.0
		Settings 0.1~3600sec	
✎	0409	Door Open Deceleration Time 1	
	Control mode	VF VFPG SVC FOC PG FOC PM	Factory setting: 1.0
		Settings 0.1~3600sec	
✎	0410	Door Open Holding Torque Level	
	Control mode	VF VFPG SVC FOC PG FOC PM	Factory setting: 50.0
		Settings 0.0~150.0% (AC drive's rated current)	

📖 Door open distance (Pr.04-01) is set in pulses number but when converting into %; it must be smaller than the setting in Pr.04-04. Door close completely is 0% and door open completely is 100%.

📖 Please refer to the diagram below and adjust door open/close curve to your requirement.

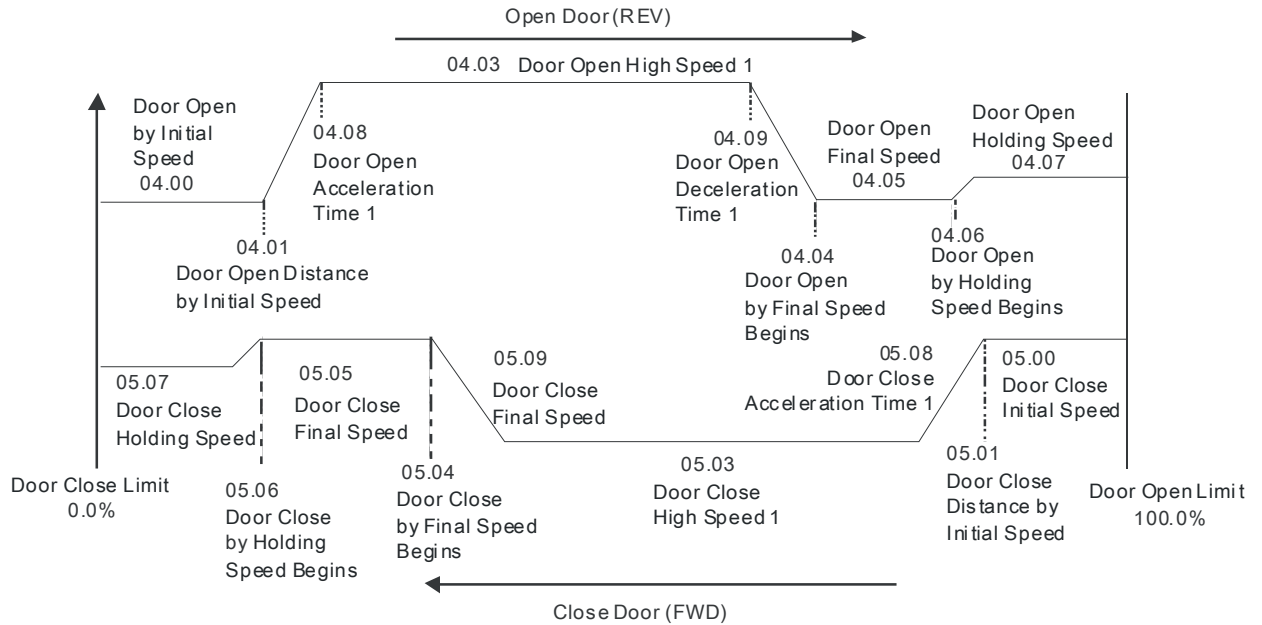

04.11 Door Open Holding Torque

Control mode **VF VFPG SVC FOC PG FOC PM** Factory setting: 30.0
Settings 0.0~100.0% (AC drive's rated current)

04.12 Response Time of Door Open Holding Torque

Control mode **VF VFPG SVC FOC PG FOC PM** Factory setting: 0.20
Settings 0.01~10.00sec

When the door is in the open complete position, it needs holding torque to keep the door still in complete position. To prevent motor overload, holding torque should be set within a limit.

04.13 Door Open High Speed 2

Control mode **VF VFPG SVC FOC PG FOC PM** Factory setting: 30.00
Settings 0.00~400.0Hz

04.14 Door Open Acceleration Time 2

Control mode **VF VFPG SVC FOC PG FOC PM** Factory setting: 1.0
Settings 0.1~3600sec

04.15 Door Open Deceleration Time 2

Control mode **VF VFPG SVC FOC PG FOC PM** Factory setting: 1.0
Settings 0.1~3600sec

04.16 Door Open Holding Torque 2

Control mode **VF VFPG SVC FOC PG FOC PM** Factory setting: 0.0
Settings 0.0~150.0% (AC drive's rated current)

04.17 Door Open Time-out Setting

Control mode **VF VFPG SVC FOC PG FOC PM** Factory setting: 0.0
Settings 0.0~180.0sec (0.0 sec: Disable)

04.18 Holding Time for OD (Open Door)Terminal

Control mode **VF VFPG SVC FOC PG FOC PM** Factory setting: 0.0
Settings 0.0~999.9sec (999.9 sec for always holding)

This parameter is used to clear the OD terminal signal (door open signal) when door open complete. During the holding period, AC Motor Drive will still be in RUN status. After holding time, AC Motor Drive will STOP. The holding time is valid only when door open has reached the complete position.

Within the holding time, when CD command (door close command) is given, the drive will begin door close action.

When Pr.04-18 set to 999.9, OD terminal is executing a permanent holding command, user can only terminate this command by using the STOP/RESET key on digital keypad.

04.19 Door Open Acceleration Time of S1 Curve

Control mode **VF VFPG SVC FOC PG FOC PM** Factory setting: 0.0
Settings 0.0~10.0sec

04.20 Door Open Acceleration Time of S2 Curve

Control mode **VF VFPG SVC FOC PG FOC PM** Factory setting: 0.0
Settings 0.0~10.0sec

This parameter is used to ensure smooth acceleration and deceleration via S-curve, different setting will create different S-curve. When this function is activated, the drive will create a smooth acceleration and deceleration curve by original acceleration and deceleration time. Setting Pr.04-19=0.0 or Pr.04-20=0.0 will create a linear acceleration and deceleration curve.

Actual acceleration time = the selected acceleration time for door open + (Pr.04.19 + Pr.04.20)/2

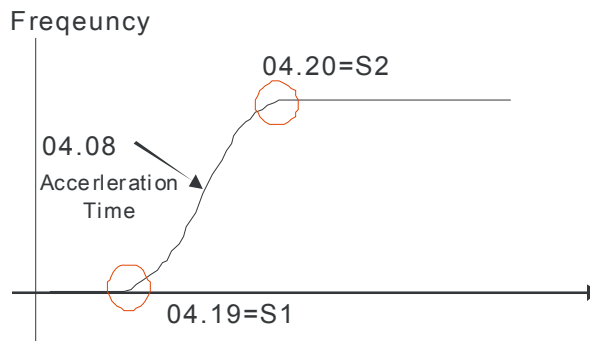

04.21 Door Open DC Brake Current Level

Control mode **VF VFPG SVC** Factory setting: 0
Settings 0~100%

This parameter sets the level of DC Brake Current output to the motor during start-up and stopping. When setting DC Brake Current, the Rated Current (Pr.00-01) is regarded as 100%. It is recommended to start with a low DC Brake Current Level and then increase until proper holding torque has been attained. Do not set Pr.04-21 greater than rated current in order to prevent motor damage. Also for your personal safety, do not use DC braking for door holding action.

When AC motor drive is in FOC PG/FOC PM control mode, DC brake functions are ready to use, no additional setting is required.

04.22 Door Open DC Brake Time when Startup

Control mode **VF VFPG SVC FOC PG FOC PM** Factory setting: 0.0
Settings 0.0~60.0sec

This parameter determines the duration of the DC Brake current after a RUN command.

04.23 Door Open DC Brake Time when Stopping

Control mode **VF VFPG SVC FOC PG FOC PM** Factory setting: 0.0
Settings 0.0~60.0sec

This parameter determines the duration of the DC Brake current during braking.



0424

Door Open DC Brake Starting Frequency

Control mode **VF** **VFP** **SVC** **FOCP**

Factory setting: 0.00

Settings 0.00~120.00Hz



During the period AC motor drive decelerating to stop, this parameter sets the DC brake starting frequency. If Pr.04-24 is lower than Pr.01-09 (starting frequency), DC brake will regard lowest frequency as starting frequency.

05 Door Close Parameters

⚡ This parameter can be set during operation.

⚡	05.00	Door Close initial Speed	
	Control mode	VF VFPG SVC FOC PG FOC PM	Factory setting: 2.00
		Settings 0.00~120.0Hz	
⚡	05.01	Door Close Distance by Initial Speed	
	Control mode	VF VFPG SVC FOC PG FOC PM	Factory setting: 0
		Settings 0~65535 (Unit: pulses number)	
⚡	05.02	Door Close Time by Initial Speed	
	Control mode	VF VFPG SVC FOC PG FOC PM	Factory setting: 0
		Settings 0.0~20.0s	
⚡	05.03	Door Close High Speed 1	
	Control mode	VF VFPG SVC FOC PG FOC PM	Factory setting: 15.00
		Settings 0.00~120.0Hz	
⚡	05.04	Door Close by Final Speed Begins	
	Control mode	VF VFPG SVC FOC PG FOC PM	Factory setting: 10.0
		Settings 0.0~100.0% (0.0%=door completely close, 100.0%= door completely open)	
⚡	05.05	Door Close Final Speed	
	Control mode	VF VFPG SVC FOC PG FOC PM	Factory setting: 5.00
		Settings 0.00~120.0Hz	
⚡	05.06	Door Close by Holding Speed begins	
	Control mode	VF VFPG SVC FOC PG FOC PM	Factory setting: 5.0
		Settings 0.0~100.0% (0.0%=door completely close, 100.0%= door completely open)	
⚡	05.07	Door Close Holding Speed	
	Control mode	VF VFPG SVC FOC PG FOC PM	Factory setting: 2.00
		Settings 0.00~120.0Hz	
⚡	05.08	Door Close Acceleration Time 1	
	Control mode	VF VFPG SVC FOC PG FOC PM	Factory setting: 1.0
		Settings 0.1~3600sec	
⚡	05.09	Door Close Deceleration Time 1	
	Control mode	VF VFPG SVC FOC PG FOC PM	Factory setting: 1.0
		Settings 0.1~3600sec	
⚡	05.10	Door Close Holding Torque Level	
	Control mode	VF VFPG SVC FOC PG FOC PM	Factory setting: 50.0
		Settings 0.0~150.0% (Drive's rated current)	

📖 Please refer to the diagram below and adjust door open/close curve to your requirement.

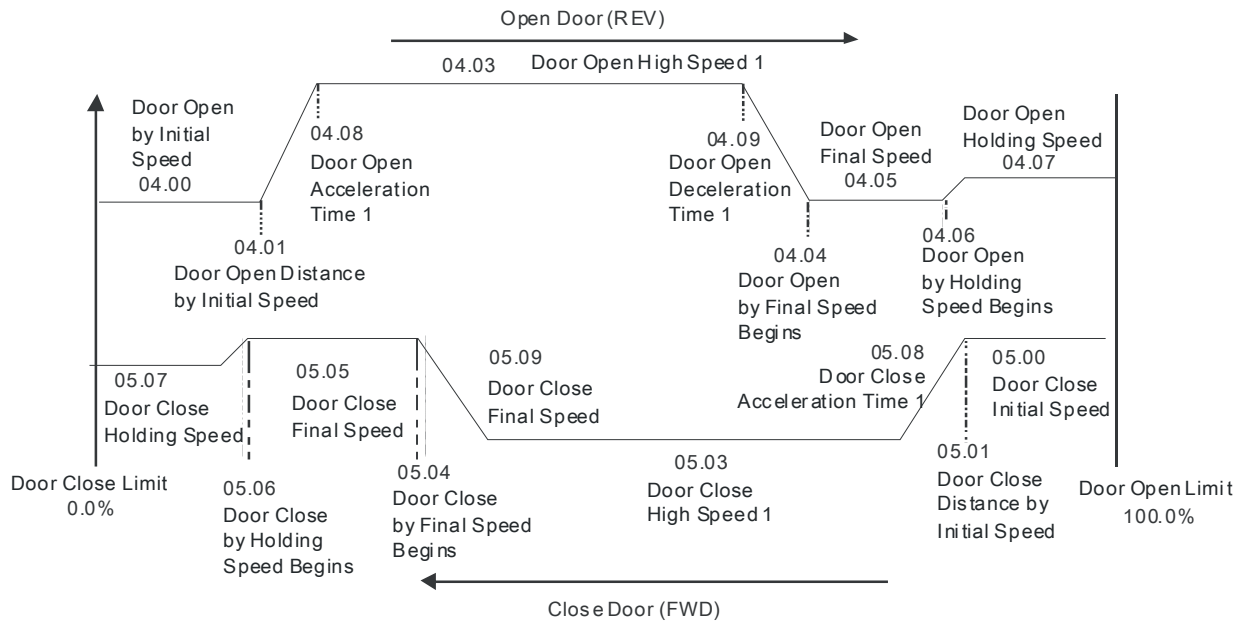

05.11 Door Close Holding Torque

Control mode **VF VFPG SVC FOC PG FOC PM** Factory setting: 30.0
Settings 0.0~100.0% (Drive's rated current)

05.12 Response Time of Door Close Holding Torque

Control mode **VF VFPG SVC FOC PG FOC PM** Factory setting: 0.20
Settings 0.01~10.00sec

When the door is in the close complete position, it needs holding torque to keep the door still in complete position. To prevent motor overload, holding torque should be set within a limit.

05.13 Door Close High Speed 2

Control mode **VF VFPG SVC FOC PG FOC PM** Factory setting: 30.00
Settings 0.00~120.0Hz

05.14 Door Close Acceleration Time 2

Control mode **VF VFPG SVC FOC PG FOC PM** Factory setting: 1.0
Settings 0.1~3600sec

05.15 Door Close Deceleration Time 2

Control mode **VF VFPG SVC FOC PG FOC PM** Factory setting: 1.0
Settings 0.1~3600sec

05.16 Door Close Holding Torque Level 2

Control mode **VF VFPG SVC FOC PG FOC PM** Factory setting: 0.0
Settings 0.0~150.0% (Ac drive's rated current)

05.17 Door Close Time-out Setting

Control mode **VF VFPG SVC FOC PG FOC PM** Factory setting: 0.0
Settings 0.0~180.0sec (0.0sec:Disable)

When the time for door closing is longer than the setting in Pr.05-17, door will re-open.

05.18 Holding Time for CD (Close Door)Terminal

Control mode **VF VFPG SVC FOC PG FOC PM** Factory setting: 0.0
Settings 0.0~999.9sec (999.9sec is always holding)

This parameter is used to clear the CD terminal signal (door close signal) when door open complete. During the holding period, AC Motor Drive will still be in RUN status. After holding time, AC Motor Drive

will STOP. The holding time is valid only when door open has reached the complete position.

📖 Within the holding time, when OD command (door open command) is given, the drive will begin door close action.

📖 When Pr.05-18 set to 999.9, CD terminal is executing a permanent holding command, user can only terminate this command by using the STOP/RESET key on digital keypad.

⚡ **05.19** Door Close Acceleration Time of S1 Curve

Control mode **VF VFPG SVC FOC PG FOC PM** Factory setting: 0.0
Settings 0.0~10.0sec

⚡ **05.20** Door Close Acceleration Time of S2 Curve

Control mode **VF VFPG SVC FOC PG FOC PM** Factory setting: 0.0
Settings 0.0~10.0sec

📖 This parameter is used to ensure smooth acceleration and deceleration via S-curve, different setting will create different S-curve. When this function is activated, the drive will create a smooth acceleration and deceleration curve by original acceleration and deceleration time. Setting Pr.05-19=0.0 or Pr.05-20=0.0 will create a linear acceleration and deceleration curve.

📖 Actual acceleration time = the selected acceleration time for door close + (Pr.05.19 + Pr.05.20)/2

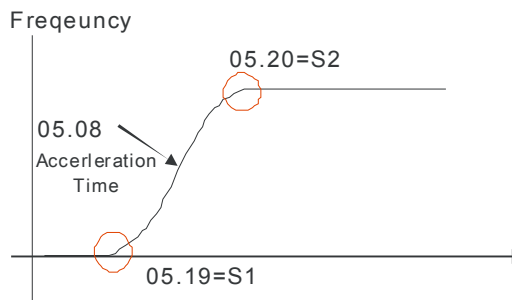

⚡ **05.21** Door Close DC Brake Current Level

Control mode **VF VFPG SVC** Factory setting: 0
Settings 00~100%

📖 This parameter sets the level of DC Brake Current output to the motor during start-up and stopping. When setting DC Brake Current, the Rated Current (Pr.00-01) is regarded as 100%. It is recommended to start with a low DC Brake Current Level and then increase until proper holding torque has been attained. Do not set Pr.05-21 greater than rated current in order to prevent motor damage. Also for your personal safety, do not use DC braking for door holding action.

📖 When AC motor drive is in FOC PG/FOC PM control mode, DC brake functions are ready to use, no additional setting is required.

⚡ **05.22** Door Close DC Brake Time when Startup

Control mode **VF VFPG SVC FOC PG FOC PM** Factory setting: 0.0
Settings 0.0~60.0sec

📖 This parameter determines the duration of the DC Brake current after a RUN command.

⚡ **05.23** Door Close DC Brake Time when Stopping

Control mode **VF VFPG SVC FOC PG FOC PM VF** Factory setting: 0.0
Settings 0.0~60.0sec

📖 This parameter determines the duration of the DC Brake current during braking.

- ⚡ **0524** Door Close DC Brake Starting Frequency
- Control mode **VF VFPG SVC FOC PG** Factory setting: 0.00
Settings 0.00~120.00Hz
- 📖 During the period AC motor drive decelerating to stop, this parameter sets the DC brake starting frequency. If Pr.05-24 is lower than Pr.01-09 (starting frequency), DC brake will regard lowest frequency as starting frequency.
-
- ⚡ **0525** Door Re-open Current Level 1
- Control mode **VF VFPG SVC FOC PG FOC PM VF** Factory setting: 100.0
Settings 0.0~150.0% (AC drive's rated current)
-
- ⚡ **0526** Door Re-open Current Level 1 for Acceleration Area
- Control mode **VF VFPG SVC FOC PG FOC PM** Factory setting: 150
Settings 100~200% (100% is Pr.05-25 setting)
-
- ⚡ **0527** Door Re-open Current Level 1 for Low Speed Area
- Control mode **VF VFPG SVC FOC PG FOC PM** Factory setting: 100.0
Settings 0.0~150.0%(Drive's rated current)
- 📖 Pr.05-25~05-27 is setting for door open/close curve set 1. When one of MI (Pr.02-01~02-05) is set to 25, door open/close curve switch to 2nd set.
-
- ⚡ **0528** Door Re-open Current Level 2
- Control mode **VF VFPG SVC FOC PG FOC PM** Factory setting: 100.0
Settings 0.0~150.0%(Drive's rated current)
-
- ⚡ **0529** Door Re-open Current Level 2 for Acceleration Area
- Control mode **VF VFPG SVC FOC PG FOC PM** Factory setting: 150
Settings 0.0~150.0% (Drive's rated current)
-
- ⚡ **0530** Door Re-open Current Level 2 for Low Speed Area
- Control mode **VF VFPG SVC FOC PG FOC PM** Factory setting: 100
Settings 100~200%(100% is the setting in Pr.05-29)
- 📖 Pr.05-28~05-30 is setting for door open/close curve set 2. When one of MI (Pr.02-01~02-05) is set to 25, door open/close curve switch to 2nd set.
-
- ⚡ **0531** Door Re-open Low Speed Boundary
- Control mode **VF VFPG SVC FOC PG FOC PM** Factory setting: 2.0
Settings 1.0~99.0%(Total door width=100%; range between 0%~Pr.05.31 is excluded from low speed detection area)
-
- ⚡ **0532** Door Re-open Acceleration Boundary
- Control mode **VF VFPG SVC FOC PG FOC PM** Factory setting: 70.0
Settings 8.0~97.0% (Total door width =100%; range between Pr.05.32~100% is the acceleration area)
- 📖 During the door close, it will re-close from the open complete position to the close complete position when there is an obstacle (the stall current exceeds Pr. 05.25/05.26/05.28/05.29). Door close command will be ignored when the drive is perform re-opening and will be valid again after door completely open is reached.
- 📖 Pr.05-33 sets the time for decelerating to 0 Hz when door close error occurs. It is recommended to set a minimum value less than the current limit in order for door to re-open in shortest time to ensure passenger's safety.

📖 Larger current is required at the beginning of door open and door close, so it needs to have larger re-open current level in the acceleration area. Please refer to the following figure for setting reopen current and acceleration area:

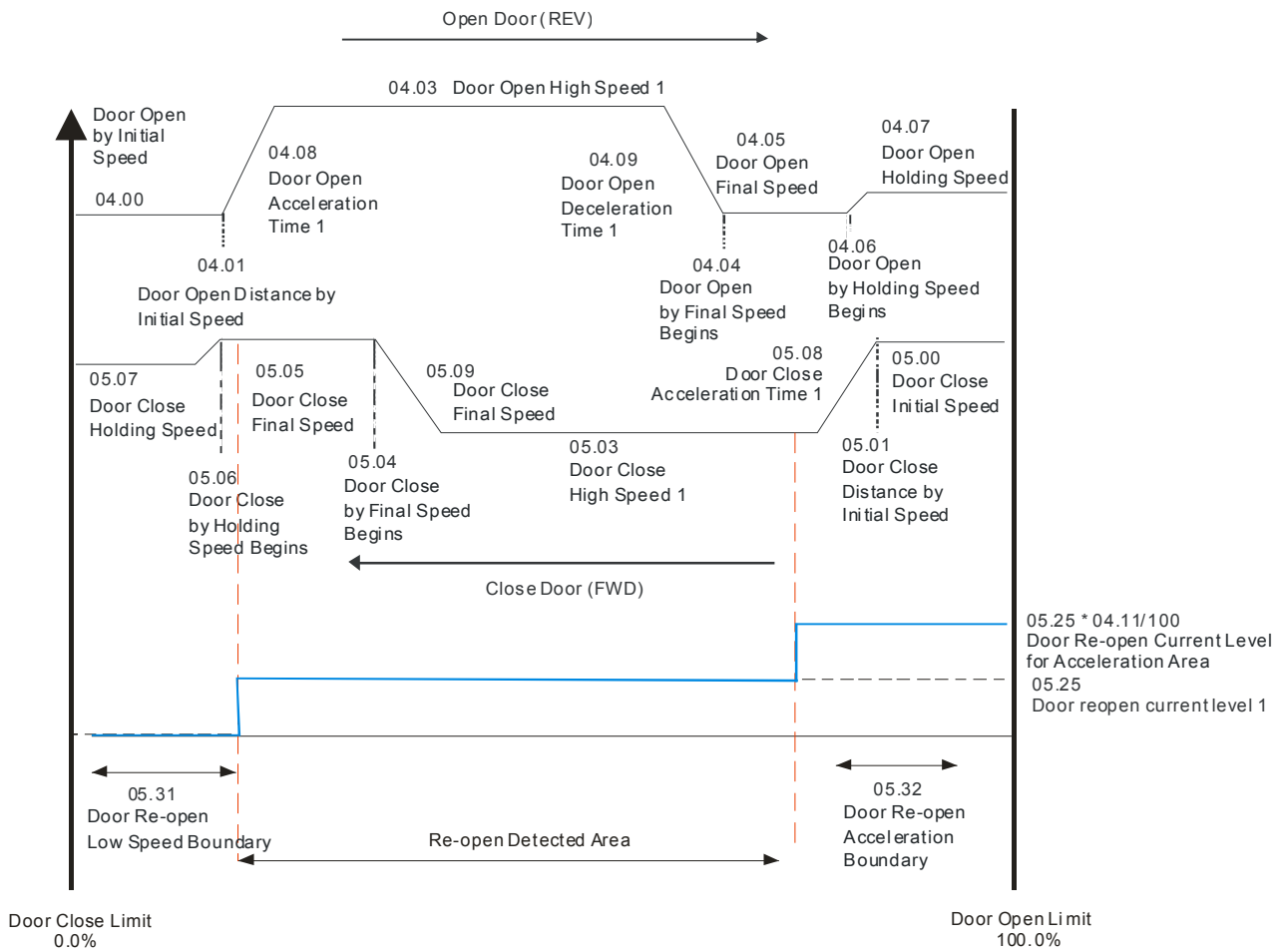

- 05.33 **Door Close Error Deceleration Time**
 Control mode **VF VFPG SVC FOC PG FOC PM** Factory setting: 0.4
 Settings 0.1~3600sec

- 05.34 **Door Re-open Detection Time**
 Control mode **VF VFPG SVC FOC PG FOC PM** Factory setting: 0.2
 Settings 0~10.0sec

06 Protection and Special Parameters

⚡ This parameter can be set during operation.

⚡ **06.00** Software Braking Level
Control mode **VF VFPG SVC FOC PG FOC PM** Factory setting: 380.0
Settings 350.0~450.0Vdc

📖 This parameter sets the software braking level, please refer to the DC voltage range on DC bus as reference.

⚡ **06.01** ED Setting of Brake Resistor
Control mode **VF VFPG SVC FOC PG FOC PM** Factory setting: 50
Settings 0~100%

⚡ **06.02** Current Boundary
Control mode **FOC PG FOC PM** Factory setting: 200
Settings 0~250%

📖 This parameter sets the maximum output current of AC drive.

⚡ **06.03** Forward Motor Torque Limit
Control mode **FOC PG FOC PM** Factory setting: 200
Settings 0~300%

⚡ **06.04** Forward Regenerative Torque Limit
Control mode **FOC PG FOC PM** Factory setting: 200
Settings 0~300%

⚡ **06.05** Reverse Motor Torque Limit
Control mode **FOC PG FOC PM** Factory setting: 200
Settings 0~300%

⚡ **06.06** Reverse Regenerative Torque Limit
Control mode **FOC PG FOC PM** Factory setting: 200
Settings 0~300%

📖 Motor rated torque is 100%. The diagram below refers to the torque limit setting in Pr.06-03 to Pr.06-06.

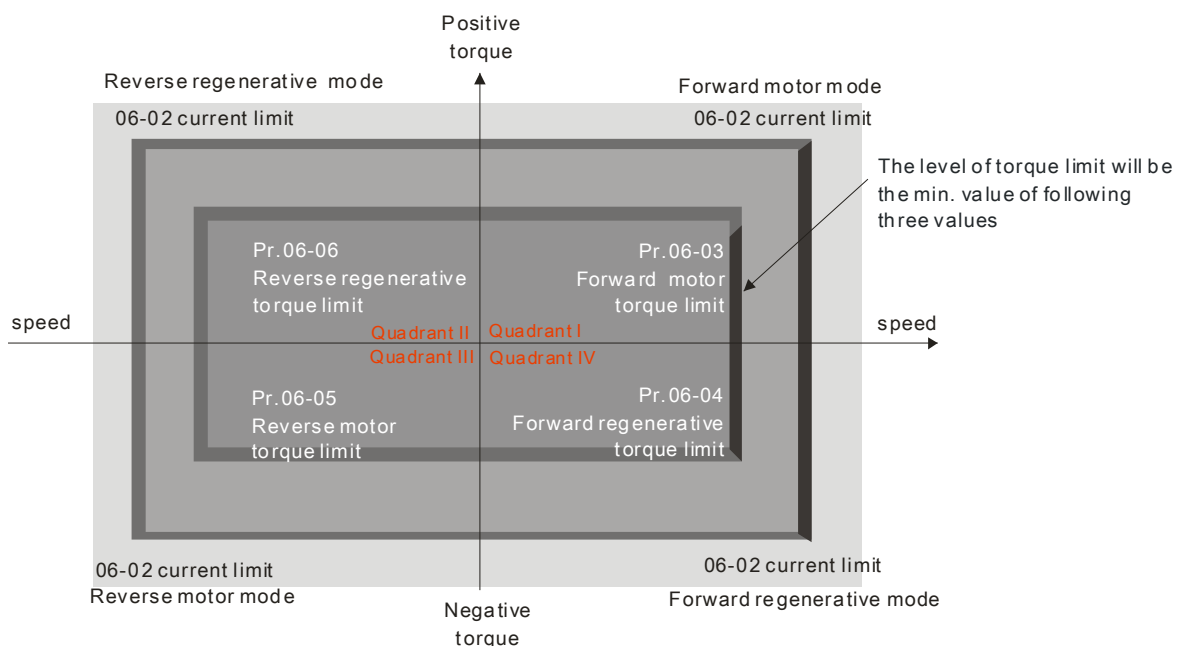

06.07 Emergency/Force Stop Deceleration Method

Control mode **VF VFPG SVC FOC PG FOC PM**

Factory setting: 3

- Settings
- 0:Coast to stop
 - 1: Decelerate by 1st decel. time
 - 2: Decelerate by 2nd decel. time
 - 3:By Pr.05.33 setting

When multi-function input terminal (MI) is set to 09 or 11, this parameter is active and the drive will operate as the setting in Pr.06-07.

06.08 Low Voltage Level

Control mode **VF VFPG SVC FOC PG FOC PM**

Factory setting: 180.0

Settings 160.0~220.0Vdc

06.09 High Temperature Overheat Warning (OH)

Control mode **VF VFPG SVC FOC PG FOC PM**

Factory setting: 85.0

Settings 0.0~110.0°C

06.10 Action after door re-open/re-close

Control mode **VF VFPG SVC FOC PG FOC PM**

Factory setting: 2

- Settings
- Bit0=0: Disable to detect the incorrect open/close limit function
 - Bit0=1: Enable to detect the incorrect open/close limit function
 - Bit1=0: Enable to re-open when door close error
 - Bit1=1: Disable to re-open when door close error
 - Bit2=0: Enable S-Curve when re-open
 - Bit2=1: Disable S-Curve when re-open
 - Bit3=0: Disable to reset door width to 100.0% after door open completed
 - Bit3=1: Enable to reset door width to 100.0% after door open completed

When Bit 0=1, if the drive is in distance control mode, it is able to detect the door open/close error; in addition, when MO(multi-function output terminal) is set to 8, the drive will output door open/close error warning.

In Distance Control Mode, the detection method for the incorrect door open/close limit is shown as follows.

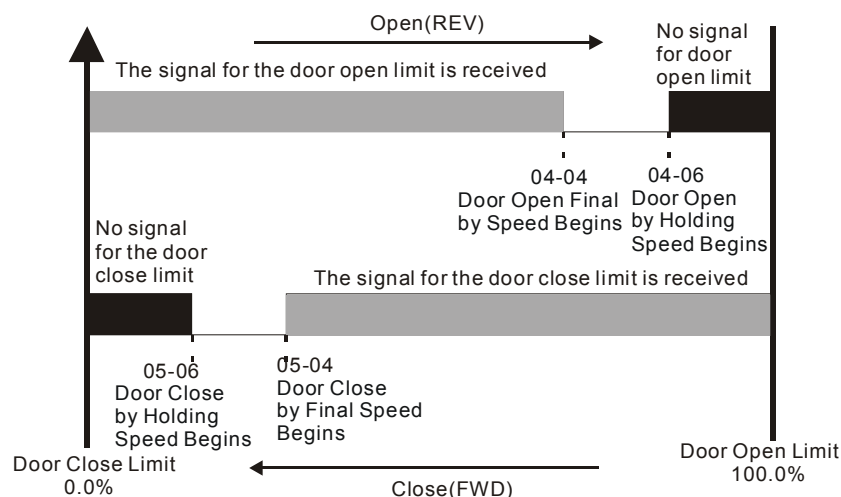

1. Incorrect door close limit:
 - a. The signal for the door open limit is received before Pr.05-04 setting.
 - b. The signal for the door open limit isn't received after Pr.05-06 setting.

2. Incorrect door open limit:
 - a. The signal for the door close limit is received before Pr.04-04 setting.
 - b. The signal for the door close limit isn't received after Pr.04-06 setting.

 When bit 1=1, the drive will not re-open the door when it detects a door closing torque higher than Pr.05-25 (05-28).

 When bit 3=1 and the drive is in torque holding status after door open completely, the door width is auto-reset to 100.0%.

06.11 Position Control Mode

Control mode	VF	VFPG	SVC	FOCPG	FOCPM	Factory setting: 0
Settings	0: No limit signal, detect by PG number and current level.					
	1: Door open limit signal only, door close by PG number or current level detection.					
	2: Door close limit signal only, door open by PG number or current level detection.					
	3: Door open and close limit signal					
	4: Detect by PG number and also accept external door open/close limit signal					
	5: No limit signal, detect by PG number and current level. (For Pr.00-09=3 speed control mode)					

 When Pr.06-11 setting is 1 to 5 and Pr. 06-12 is NOT set to 0, the AC drive will regard this setting as open/close complete position if following two conditions are met:

- A. It has open/close limit signal.
- B. When the stall current level exceeds Pr.06-12.

 When this parameter is set to 0 "No limit signal", the door open/close complete position can be check by following two methods:.

- A. When Pr. 06-12 is set to 0: When PG feedback frequency is almost 0 due to motor stall, it is regarded as open/close complete position.
- B. When Pr. 06-12 is NOT set to 0: When current exceeds this level due to motor stall, it is regarded as open/close complete position.

NOTE

1. It is recommended to use method B for the transmission mechanism skids easily.
2. This function works in distance control mode only. For multi-step control mode, please use door open/close limit signal to verify if door reaches its open/close complete position.

06.12 Stall Current Level of Position Mode

Control mode	VF	VFPG	SVC	FOCPG	FOCPM	Factory setting: 30.0
Settings	0.0~200.0% (AC drive's rated current)					

 This parameter sets the stall current level for open/close complete position and is to be used with Pr.06-11.

06.13 Door Open/Close Holding Time Before Next Demo

Control mode	VF	VFPG	SVC	FOCPG	FOCPM	Factory setting: 2.0
Settings	0.0~999.9sec					

 During demonstration in demo mode, this parameter sets the door holding time before it goes on to the next demonstration.

✎ **06.14** Times of Door Opened/Closed in Demo Mode (L)

Control mode **VF VFPG SVC FOC PG FOC PM** Factory setting: 0
 Settings 0~9999

✎ **06.15** Times of Door Opened/Closed in Demo Mode (H)

Control mode **VF VFPG SVC FOC PG FOC PM** Factory setting: 0
 Settings 0~9999

📖 When executing demo mode, it records the number of times the door opened or closed. It counts as one when door action from open to close.

✎ **06.16** Clear Demo Mode Door Open/Close Record

Control mode **VF VFPG SVC FOC PG FOC PM** Factory setting: 0
 Settings 0: Disable
 1: Clear (Pr.06.14 and Pr.06.15)

📖 When Pr.06-16 is set to 1, door open/close counting will be cleared and reset to 0.

✎ **06.17** Present Fault Record

✎ **06.18** 2nd Most Recent Fault Record

✎ **06.19** 3rd Most Recent Fault Record

✎ **06.20** 4th Most Recent Fault Record

✎ **06.21** 5th Most Recent Fault Record

✎ **06.22** 6th Sixth Most Recent Fault Record

Control mode **VF VFPG SVC FOC PG FOC PM** Factory setting: 00

- Settings
- 0: No fault
 - 1: Over-current during acceleration (ocA)
 - 2: Over-current during deceleration (ocd)
 - 3: Over-current during steady speed (ocn)
 - 4: Reserved
 - 5: Reserved
 - 6: Over-current at stop (ocS)
 - 7: Over voltage during acceleration (ovA)
 - 8: Over voltage during deceleration (ovd)
 - 9: Over voltage during steady speed (ovn)
 - 10: Over voltage at stop (ovS)
 - 11: Low voltage during acceleration (LvA)
 - 12: Low voltage during deceleration (Lvd)
 - 13: Low voltage during steady speed (Lvn)
 - 14: Low voltage at stop (LvS)
 - 15: Phase loss protection (PHL)
 - 16: IGBT overheat (oH1)
 - 17: Reserved
 - 18: IGBT overheat protection circuit error (tH1o)
 - 19~20: Reserved
 - 21: 150% 1Min, AC drive overload (oL)
 - 22: Motor overload (EoL1)
 - 23~29: Reserved
 - 30: Memory write-in error (cF1)
 - 31: Memory read-out error (cF2)
 - 32: Isum current detection error (cd0)
 - 33: U-phase current detection error (cd1)
 - 34: V-phase current detection error (cd2)
 - 35: W-phase current detection error (cd3)
 - Clamp current detection error (Hd0)
 - 37: Over-current detection error (Hd1)

- 38 Over-voltage detection error (Hd2)
- 39 Ground current detection error (Hd3)
- 40 Auto tuning error (AuE)
- 41: Reserved
- 42: PG feedback error (PGF1)
- 43 PG feedback loss (PGF2)
- 44 PG feedback stall (PGF3)
- 45 PG slip error (PGF4)
- 46~48: Reserved
- 49:External fault signal input
- 50~51: Reserved
- 52:Password error (PcodE)
- 53:Software error (ccodE)
- 54:Communication time-out (cE1)
- 55: Communication time-out (cE2)
- 56: Communication time-out (cE3)
- 57: Communication time-out (cE4)
- 58 Communication time-out (cE10)
- 59:PU time-out (cP10)
- 60: Brake chopper error (bF)
- 61~67: Reserved
- 68: Door open/close complete signal error
- 69:Door open time-out (DOT)

The drive is forced to stop each time fault occurs and will be recorded. When fault occurs at STOP status, LV warning will be given but will not be recorded. When fault occurs at RUN, LV error will be given and will be recorded.

06.23 Electronic Thermal Overload Relay Selection

Control mode **VF VFPG SVC FOC PG FOC PM** Factory setting: 2
 Settings 0: Special motor for AC drive
 1: Standard motor
 2: Disable

This parameter sets the boundary of the drive's output power. This function is used to protect the motor from overloading or overheating when it operates in low speed.

06.24 Electronic Thermal Characteristic

Control mode **VF VFPG SVC FOC PG FOC PM** Factory setting: 60.0
 Settings 30.0~600.0sec

The parameter determines the time required for activating the electronic thermal protection function. The protection function regards to the drive's output frequency, current and operation time. The graph below shows the curves for 150% output power in a time limit set in Pr.06-23.

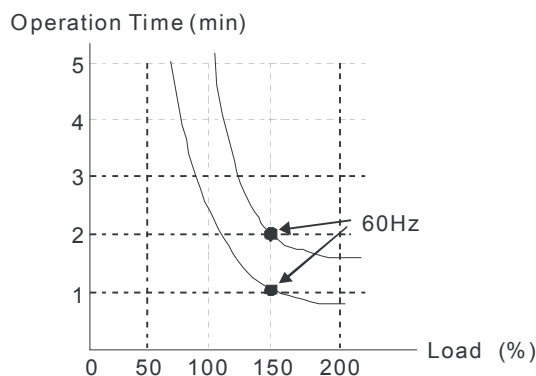

↗ **06.25** Auto Restart After Fault

Control mode **VF VFPG SVC FOC PG FOC PM**
Settings 0~10

Factory setting: 0

- 📖 After fault occurs (oc and ov), the AC motor drive can be reset/restarted automatically up to 10 times.
- 📖 Setting this parameter to 0 will disable the reset/restart operation after any fault has occurred. When enabled, the AC motor drive will restart with speed search, which starts at the frequency before the fault.
- 📖 If the drive execute reset/restart after fault more than the numbers of time set in Pr.06-25 and the limit is reached within the time period in Pr.06-26, the drive will stop execute reset/restart after fault function. User will need to input RESET manually for the drive to continue operation.

↗ **06.26** Auto Reset Time for Restart after Fault

Control mode **VF VFPG SVC FOC PG FOC PM**
Settings 0.1~600.0sec

Factory setting: 60.0

- 📖 When a reset/restart after fault occurs, the drive will regards Pr.06-26 as a time boundary and begin counting the numbers of faults occur within this time period. Within the period, if numbers of faults occurred did not exceed the setting in Pr.06-25, the counting will be cleared and starts from 0 when next fault occurs.

07 Control Parameters

↗ This parameter can be set during operation.

↗	07.00	ASR (Auto Speed Regulation) Control (P) of Zero Speed	
Control mode	VF VFPG SVC FOC PG FOC PM		Factory setting: 1.5
Settings	0.0~500.0%		
↗	07.01	ASR (Auto Speed Regulation) Control (I) of Zero Speed	
Control mode	VF VFPG SVC FOC PG FOC PM		Factory setting: 0.05
Settings	0.000~10.000sec		
↗	07.02	ASR (Auto Speed Regulation) Control (P) 1	
Control mode	VF VFPG SVC FOC PG FOC PM		Factory setting: 1.5
Settings	0.0~500.0%		
↗	07.03	ASR (Auto Speed Regulation) Control (I) 1	
Control mode	VF VFPG SVC FOC PG FOC PM		Factory setting: 0.05
Settings	0.000~10.000sec		
↗	07.04	ASR (Auto Speed Regulation) Control (P) 2	
Control mode	VF VFPG SVC FOC PG FOC PM		Factory setting: 3.0
Settings	0.0~500.0%		
↗	07.05	ASR (Auto Speed Regulation) Control (I) 2	
Control mode	VF VFPG SVC FOC PG FOC PM		Factory setting: 0.10
Settings	0.000~10.000sec		
↗	07.06	ASR 1/ASR2 Switch Frequency	
Control mode	VF VFPG SVC FOC PG FOC PM		Factory setting: 2.00
Settings	0.00~400.00Hz (0: disable)		

📖 ASR P determines Proportional control and associated gain (P). ASR I determines integral control and associated gain (I).

📖 When integral time is set to 0, it is disabled. Pr.07-06 defines the switch frequency for ASR1 (Pr.07-02, 07-03) and ASR2 (Pr.07-04, Pr.07-05).

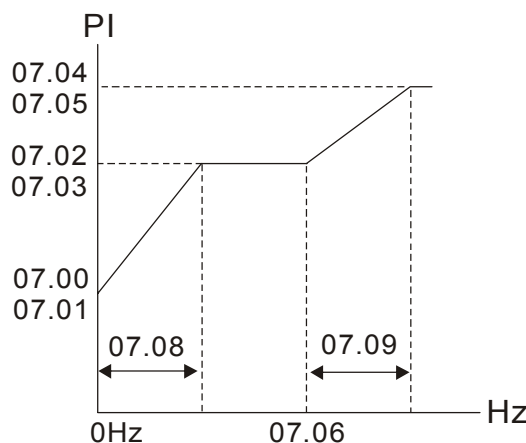

↗	07.07	ASR Primary Low Pass Filter Gain	
Control mode	VF VFPG SVC FOC PG FOC PM		Factory setting: 0.008
Settings	0.000~0.350sec		

📖 This parameter defines the filter time of the ASR command.

07.08 Zero Speed/ASR1 Width Adjustment
 Control mode **VFPG** **FOCPG** **FOCPM** Factory setting: 2.00
 Settings 0.00~400.00Hz

07.09 ASR1/ASR2 Width Adjustment
 Control mode **VFPG** **FOCPG** **FOCPM** Factory setting: 5.00
 Settings 0.00~400.00Hz

These parameters set the slope width from zero speed to low speed and from Pr.07-06 to high speed.

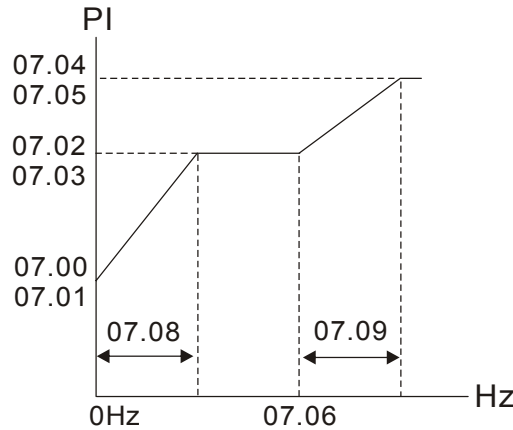

07.10 Mechanical Gear Ratio
 Control mode **FOCPG** **FOCPM** Factory setting: 1
 Settings 1~100

07.11 Inertia Ratio
 Control mode **FOCPG** **FOCPM** Factory setting: 100
 Settings 1~300%

This parameter can be used to adjust inertia ratio of load.

07.12 Zero-speed Bandwidth
 Control mode **FOCPG** **FOCPM** Factory setting: 20
 Settings 0~40Hz

07.13 Low-speed Bandwidth
 Control mode **FOCPG** **FOCPM** Factory setting: 20
 Settings 0~40Hz

07.14 High-speed Bandwidth
 Control mode **FOCPG** **FOCPM** Factory setting: 20
 Settings 0~40Hz

After estimating inertia, user can adjust parameters Pr.07-12, 07-13, and 07-14 separately by speed response. The larger value of the setting, the faster response you will get. Pr.07-06 is switches the frequency of low-speed/high-speed bandwidth.

07.15 PDFF Gain Value
 Control mode **FOCPG** **FOCPM** Factory setting: 0
 Settings 0~200%

Pr. 07-15, 07-16 is used to reduce overshoot situation. Please adjust PDFF gain value by actual situation.

Besides traditional PI control, it also provides PDFF function to reduce overshoot for speed control.

1. Get system inertia
2. Adjust Pr.07-15 and 07-16 (When larger number is set, the suppressed overshoot function will be better. But it needs to be used with the actual condition)

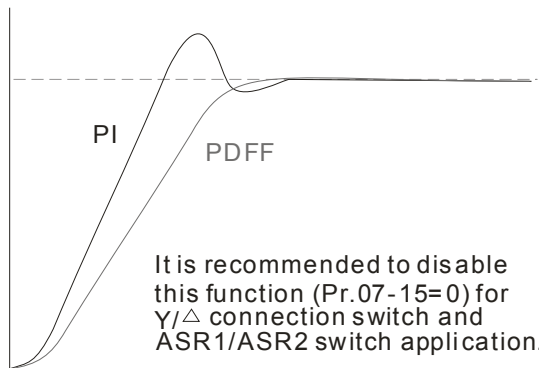

07.16

Gain for Speed Feed Forward

Control mode















FOCPG FOCPM

Factory setting: 0

Settings 0~500

08 Multi-step Speed Parameter

↗ This parameter can be set during operation.

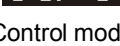
↗		Zero Step Speed Frequency
↗		1 st Step Speed Frequency
↗		2 nd Step Speed Frequency
↗		3 rd Step Speed Frequency
↗		4 th Step Speed Frequency
↗		5 th Step Speed Frequency
↗		6 th Step Speed Frequency
↗		7 th Step Speed Frequency
↗		8 th Step Speed Frequency
↗		9 th Step Speed Frequency
↗		10 th Step Speed Frequency
↗		11 th Step Speed Frequency
↗		12 th Step Speed Frequency
↗		13 th Step Speed Frequency
↗		14 th Step Speed Frequency
↗		15 th Step Speed Frequency

Control mode **VF VFPG SVC FOC PG FOC PM**
Settings 0.00~120.00Hz

Factory setting: 0.00

 The Multi-Function Input Terminals (refer to Pr.02-01 to 02-05) are used to select one of the AC motor drive Multi-step speeds. The speeds (frequencies) are determined by Pr.08-00 to 08-15 as shown above.

09 Communication Parameters

⚡ This parameter can be set during operation.

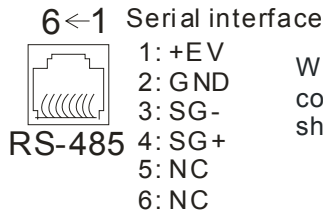

When the AC motor drive is controlled by RS-485 serial communication, a converter, VFD-USB01 or IFD8500, should be connected between the AC motor drive and PC.

⚡ 0900 Communication Address

Control mode **VF VFPG SVC FOC PG FOC PM** Factory setting: 1
Settings 01~254

📖 If the AC motor drive is controlled by RS-485 serial communication, the communication address for this drive must be set via this parameter. And the communication address for each AC motor drive must be different and unique.

⚡ 0901 Transmission Speed

Control mode **VF VFPG SVC FOC PG FOC PM** Factory setting: 19.2
Settings 4.8~115.2Kbps

📖 This parameter is used to set the transmission speed between the RS485 master (PLC, PC, etc.) and AC motor drive. RS-485 communication can also be used to change the drive's parameter and control the drive's operation status.

⚡ 0902 Transmission Fault Treatment

Control mode **VF VFPG SVC FOC PG FOC PM** Factory setting: 3
Settings Warn and keep operating
Warn and RAMP to stop
Reserved
No action and no display

📖 This parameter is used to set the reaction to transmission errors occur.

⚡ 0903 Time-out Detection

Control mode **VF VFPG SVC FOC PG FOC PM** Factory setting: 0.0
Settings 0.0~100.0sec

📖 This parameter is used to set the duration of communication and keypad time-out.

⚡ 0904 Communication Protocol

Control mode **VF VFPG SVC FOC PG FOC PM** Factory setting: 13
Settings 0: 7N1 (ASCII)
1: 7N2 (ASCII)
2: 7E1 (ASCII)
3: 7O1 (ASCII)
4: 7E2 (ASCII)
5: 7O2 (ASCII)
6: 8N1 (ASCII)
7: 8N2 (ASCII)
8: 8E1 (ASCII)
9: 8O1 (ASCII)
10: 8E2 (ASCII)
11: 8O2 (ASCII)
12: 8N1 (RTU)
13: 8N2 (RTU)

- 14: 8E1 (RTU)
- 15: 8O1 (RTU)
- 16: 8E2 (RTU)
- 17: 8O2 (RTU)

1. Control by PC or PLC

★ A VFD-VL can be set up to communicate on Modbus networks using one of the following modes: ASCII (American Standard Code for Information Interchange) or RTU (Remote Terminal Unit). Users can select the desired mode along with the serial port communication protocol in Pr.09-04.

★ Code Description:

ASCII mode:

Each 8-bit data is the combination of two ASCII characters. For example, a 1-byte data: 64 Hex, shown as '64' in ASCII, consists of '6' (36Hex) and '4' (34Hex).

Character	'0'	'1'	'2'	'3'	'4'	'5'	'6'	'7'
ASCII code	30H	31H	32H	33H	34H	35H	36H	37H
Character	'8'	'9'	'A'	'B'	'C'	'D'	'E'	'F'
ASCII code	38H	39H	41H	42H	43H	44H	45H	46H

2. Data Format

10-bit character frame (For ASCII):

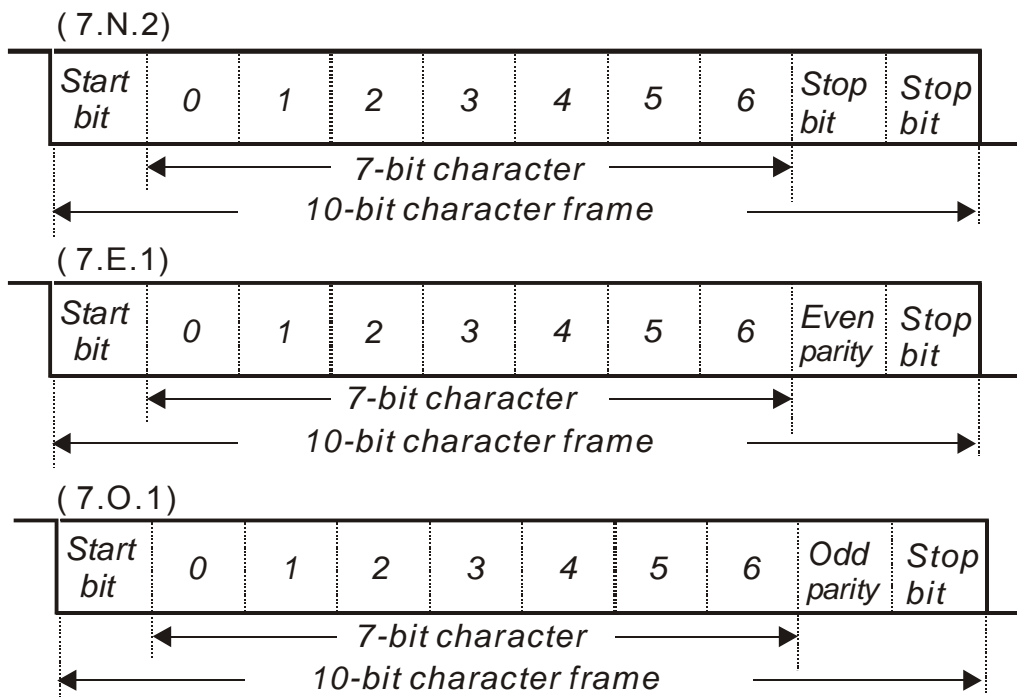

11-bit character frame (For RTU):
(8.N.2)

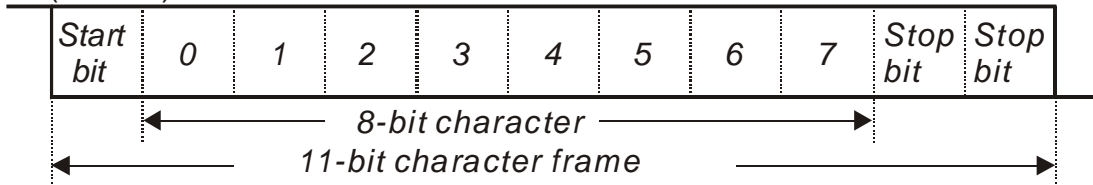

(8.E.1)

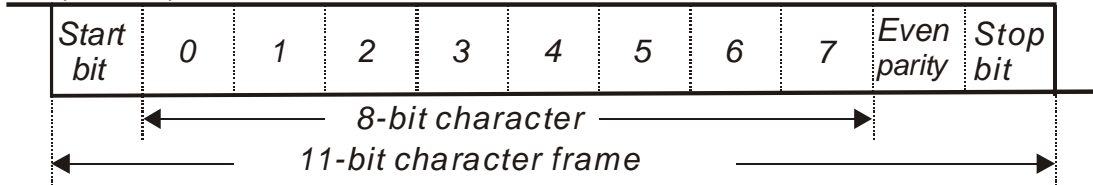

(8.O.1)

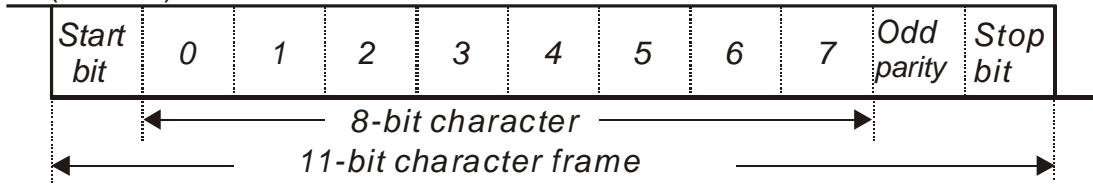

3.1 Communication Protocol

Communication Data Frame:

ASCII mode:

STX	Start character ':' (3AH)
Address Hi	Communication address: 8-bit address consists of 2 ASCII codes
Address Lo	
Function Hi	Command code: 8-bit command consists of 2 ASCII codes
Function Lo	
DATA (n-1)	Contents of data: Nx8-bit data consist of 2n ASCII codes n<=16, maximum of 32 ASCII codes
.....	
DATA 0	
LRC CHK Hi	LRC check sum: 8-bit check sum consists of 2 ASCII codes
LRC CHK Lo	
END Hi	End characters: END1= CR (0DH), END0= LF(0AH)
END Lo	

RTU mode:

START	A silent interval of more than 10 ms
Address	Communication address: 8-bit address
Function	Command code: 8-bit command
DATA (n-1)	Contents of data: n×8-bit data, n<=16
.....	
DATA 0	
CRC CHK Low	CRC check sum: 16-bit check sum consists of 2 8-bit characters
CRC CHK High	
END	A silent interval of more than 10 ms

 3.2 Address (Communication Address)

Valid communication addresses are in the range of 0 to 254. A communication address equal to 0, means broadcast to all AC drives (AMD). In this case, the AMD will not reply any message to the master device.

00H: broadcast to all AC drives

01H: AC drive of address 01

0FH: AC drive of address 15

10H: AC drive of address 16

:

FEH: AC drive of address 254

For example, communication to AMD with address 16 decimal (10H):

ASCII mode: Address='1','0' => '1'=31H, '0'=30H

RTU mode: Address=10H

 3.3 Function (Function code) and DATA (data characters)

The format of data characters depends on the function code.

03H: read data from register

06H: write single register

Example: reading continuous 2 data from register address 2102H, AMD address is 01H.

ASCII mode:

Command message:		Response message:	
STX	':'	STX	':'
Address	'0'	Address	'0'
	'1'		'1'
Function	'0'	Function	'0'
	'3'		'3'
Starting address	'2'	Number of data (count by byte)	'0'
	'1'		'4'
	'0'	Content of starting address 2102H	'1'
	'2'		'7'
Number of data (count by word)	'0'	Content of address 2103H	'7'
	'0'		'0'
	'0'		'0'
	'2'		'0'
LRC Check	'D'	LRC Check	'0'
	'7'		'0'
END	CR	END	'7'
	LF		'1'
			CR
			LF

RTU mode:

Command message:		Response message:	
Address	01H	Address	01H
Function	03H	Function	03H
Starting data address	21H	Number of data (count by byte)	04H
	02H		Content of data address 2102H
Number of data (count by word)	00H	Content of data address 2103H	
	02H		00H
CRC CHK Low	6FH	CRC CHK Low	FEH
CRC CHK High	F7H	CRC CHK High	5CH

06H: single write, write single data to register.

Example: writing data 6000(1770H) to register 0100H. AMD address is 01H.

ASCII mode:

Command message:		Response message:	
STX	‘.’	STX	‘.’
Address	‘0’	Address	‘0’
	‘1’		‘1’
Function	‘0’	Function	‘0’
	‘6’		‘6’
Data address	‘0’	Data address	‘0’
	‘1’		‘1’
	‘0’		‘0’
	‘0’		‘0’
Data content	‘1’	Data content	‘1’
	‘7’		‘7’
	‘7’		‘7’
	‘0’		‘0’
LRC Check	‘7’	LRC Check	‘7’
	‘1’		‘1’
END	CR	END	CR
	LF		LF

RTU mode:

Command message:		Response message:	
Address	01H	Address	01H
Function	06H	Function	06H
Data address	01H	Data address	01H
	00H		00H
Data content	17H	Data content	17H
	70H		70H
CRC CHK Low	86H	CRC CHK Low	86H
CRC CHK High	22H	CRC CHK High	22H

10H: write multiple registers (write multiple data to registers)

Example: Set the multi-step speed,

Pr.04-00=50.00 (1388H), Pr.04-01=40.00 (0FA0H). AC drive address is 01H.

ASCII Mode:

Command message:		Response message:	
STX	‘.’	STX	‘.’
ADR 1	‘0’	ADR 1	‘0’
ADR 0	‘1’	ADR 0	‘1’
CMD 1	‘1’	CMD 1	‘1’
CMD 0	‘0’	CMD 0	‘0’
Starting data address	‘0’	Starting data address	‘0’
	‘5’		‘5’
	‘0’		‘0’
	‘0’		‘0’
Number of data (count by word)	‘0’	Number of data (count by word)	‘0’
	‘0’		‘0’
	‘2’		‘2’
Number of data (count by byte)	‘0’	LRC Check	‘E’
	‘4’		‘8’
The first data content	‘1’	END	CR
	‘3’		LF
	‘8’		
The second data content	‘8’		
	‘0’		
	‘F’		

	'A'
	'0'
LRC Check	'9'
	'A'
END	CR
	LF

RTU mode:

Command message:

ADR	01H
CMD1	10H
Starting data address	05H
	00H
Number of data (count by word)	00H
	02H
Number of data (count by byte)	04
The first data content	13H
	88H
The second data content	0FH
	A0H
CRC Check Low	'9'
CRC Check High	'A'

Response message:

ADR	01H
CMD 1	10H
Starting data address	05H
	00H
Number of data (count by word)	00H
	02H
CRC Check Low	41H
CRC Check High	04H

Check sum

ASCII mode:

LRC (Longitudinal Redundancy Check) is calculated by summing up, module 256 and the values of the bytes from ADR1 to last data character then calculating the hexadecimal representation of the 2's-complement negation of the sum.

For example,

$01H+03H+21H+02H+00H+02H=29H$, the 2's-complement negation of 29H is D7H.

RTU mode:

CRC (Cyclical Redundancy Check) is calculated by the following steps:

Step 1: Load a 16-bit register (called CRC register) with FFFFH.

Step 2: Exclusive OR the first 8-bit byte of the command message with the low order byte of the 16-bit CRC register, putting the result in the CRC register.

Step 3: Examine the LSB of CRC register.

Step 4: If the LSB of CRC register is 0, shift the CRC register one bit to the right with MSB zero filling, then repeat step 3. If the LSB of CRC register is 1, shift the CRC register one bit to the right with MSB zero filling, Exclusive OR the CRC register with the polynomial value A001H, then repeat step 3.

Step 5: Repeat step 3 and 4 until eight shifts have been performed. When this is done, a complete 8-bit byte will have been processed.

Step 6: Repeat step 2 to 5 for the next 8-bit byte of the command message. Continue doing this until all bytes have been processed. The final contents of the CRC register are the CRC value. When transmitting the CRC value in the message, the upper and lower bytes of the CRC value must be swapped, i.e. the lower order byte will be transmitted first.

The following is an example of CRC generation using C language. The function takes two arguments:

Unsigned char* data ← a pointer to the message buffer

Unsigned char length ← the quantity of bytes in the message buffer

The function returns the CRC value as a type of unsigned integer.

Unsigned int crc_chk(unsigned char* data, unsigned char length)

```
{
    int j;
    unsigned int reg_crc=0Xffff;
    while (length--){
        reg_crc ^= *data++;
        for(j=0;j<8;j++){
            if(reg_crc & 0x01){ /* LSB(b0)=1 */
                reg_crc=(reg_crc>>1) ^ 0Xa001;
            }else{
                reg_crc=reg_crc >>1;
            }
        }
    }
}

return reg_crc; // return register CRC
```

Address list

Content	Address	Function			
AC drive Parameters	GGnnH	GG means parameter group, nn means parameter number, for example, the address of Pr.04-01 is 0401H.			
Drive Command	2000H	Bit0~3	0: No function 1: Stop 2: Run 3: Jog + Run		
		Bit4~5	00B: No function 01B: FWD 10B: REV 11B: Change direction		
			Bit6~7	00B: 1st accel/decel 01B: 2nd accel/decel 10B: 3rd accel/decel 11B: 4th accel/decel	
				Bit08~11	000B: master speed

			0001B: 1st accel/decel.
			0010B: 2nd accel/decel
			0011B: 3rd accel/decel
			0100B: 4th accel/decel
			0101B: 5th accel/decel
			0110B: 6th accel/decel
			0111B: 7th accel/decel
			1000B: 8th accel/decel
			1001B: 9th accel/decel
			1010B: 10th accel/decel
			1011B: 11th accel/decel
			1100B: 12th accel/decel
			1101B: 13th accel/decel
			1110B: 14th accel/decel
			1111B: 15th accel/decel
		Bit12	1: enable bit06-11 function
		Bit13~14	00B: No function
			01B: operated by digital keypad
			10B: operated by Pr.00-21 setting
			11B: change operation source
		Bit15	Reserved
	2001H	Frequency command	
	2002H	Bit0	1: EF (external fault) on
		Bit1	1: Reset
		Bit2	1: B.B. ON
		Bit3~5	Reserved
Status monitor Read only	2100H	Error code: refer to Pr.06-16 to Pr.06-21	
	2119H	Bit0	00: Stop
		Bit1	01: deceleration
		Bit2	10: Ready for operation
		Bit3	11: operation
		Bit4	
		Bit5~7	Reserved
		Bit8	1: Master frequency Controlled by communication interface
		Bit9	1: Master frequency controlled by analog/external terminals signal
		Bit10	1: Operation command controlled by communication interface
		Bit11	1: Parameters have been locked
	Bit12	1: enable to copy parameter from keypad	
	Bit13~15	Reserved	
	2102H	Frequency command (F)	
	2103H	Output frequency (H)	
	2104H	Output current (Axxx.X)	
	2105H	DC-BUS Voltage (Uxxx.X)	
	2106H	Output voltage (Exxx.X)	
	2107H	Current step number of Multi-Step Speed Operation	
	2116H	Multi-function display (Pr.00-04)	
	2120H	Frequency command when malfunction	
	2121H	Output frequency when malfunction	
	2122H	Output current when malfunction	
	2123H	Motor frequency when malfunction	
	2124H	Output voltage when malfunction	
	2125H	DC-bus voltage when malfunction	
	2126H	Output power when malfunction	
	2127H	Output torque when malfunction	
	2128H	IGBT Temperature of Power Module at Present Fault	
	2129H	Input status of multi-function terminal when malfunction (format is the same as Pr.00-04=16)	

212AH	Output status of multi-function terminal when malfunction (format is the same as Pr.00-04=17)
212BH	Drive status when malfunction (format is the same as 2119H)
2201H	Pr.00-05 user-defined setting
2203H	AUI1 analog input (XXX.XX %)
2204H	ACI analog input (XXX.XX %)
2205H	AUI2 analog input (XXX.XX %)
2206H	Display temperature of IGBT (oC)
2207H	Display temperature of heatsink (oC) (only for model 40HP and above)
2208H	Digital input state
2209H	Digital output state

Exception response:

The AC motor drive is expected to return a normal response after receiving command messages from the master device. The following depicts the conditions when no normal response is replied to the master device.

The AC motor drive does not receive the messages due to a communication error; thus, the AC motor drive has no response. The master device will eventually process a timeout condition.

The AC motor drive receives the messages without a communication error, but cannot handle them. An exception response will be returned to the master device and an error message “CExx” will be displayed on the keypad of AC motor drive. The xx of “CExx” is a decimal code equal to the exception code that is described below.

In the exception response, the most significant bit of the original command code is set to 1, and an exception code which explains the condition that caused the exception is returned.

Example:

ASCII mode:		RTU mode:	
STX	‘:’	Address	01H
Address	‘0’	Function	86H
	‘1’	Exception code	02H
Function	‘8’	CRC CHK Low	C3H
	‘6’	CRC CHK High	A1H
Exception code	‘0’		
	‘2’		
LRC CHK	‘7’		
	‘7’		
END	CR		
	LF		

The explanation of exception codes:

Exception code	Explanation
1	Illegal data value: The data value received in the command message is not available for the AC drive.
2	Illegal data address: The data address received in the command message is not available for the AC motor drive.
3	Parameters are locked: parameters can't be changed
4	Parameters can't be changed during operation
10	Communication time-out.

⚡ **0905** Response Delay Time

Control mode **VF VFPG SVC FOC PG FOC PM**

Factory setting: 2.0

Settings 0.0~200.0ms

📖 This parameter is the response delay time after AC drive receives communication command as shown in the following.

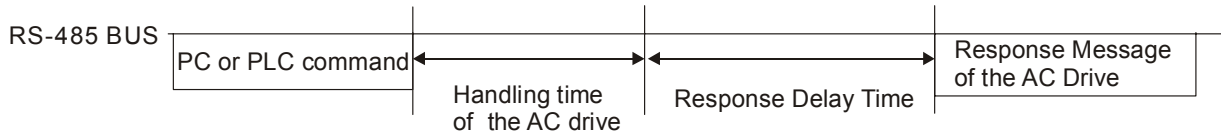

10 User-defined Parameters

⚡ This parameter can be set during operation.

⚡	10.00	Start-up Display Selection	Control mode	VF	VFP	SVC	FOCPG	TQCPG	FOCPM	Factory setting: #. ##
Display address 0003										
⚡	10.01	Maximum Operation Frequency	Control mode	VF	VFP	SVC	FOCPG	TQCPG	FOCPM	Factory setting: #. ##
Display address 0131										
⚡	10.02	Motor Rated Frequency	Control mode	VF	VFP	SVC	FOCPG	TQCPG	FOCPM	Factory setting: #. ##
Display address 0132										
⚡	10.03	Motor Rated Voltage	Control mode	VF	VFP	SVC	FOCPG	TQCPG	FOCPM	Factory setting: #. ##
Display address 0133										
⚡	10.04	2nd Output Frequency (Mid-point frequency)	Control mode	VF	VFP	SVC	FOCPG	TQCPG	FOCPM	Factory setting: #. ##
Display address 0134										
⚡	10.05	2nd Output Voltage (Mid-point voltage)	Control mode	VF	VFP	SVC	FOCPG	TQCPG	FOCPM	Factory setting: #. ##
Display address 0135										
⚡	10.06	3rd Output Frequency (Mid-point frequency)	Control mode	VF	VFP	SVC	FOCPG	TQCPG	FOCPM	Factory setting: #. ##
Display address 0136										
⚡	10.07	3rd Output Voltage (Mid-point voltage)	Control mode	VF	VFP	SVC	FOCPG	TQCPG	FOCPM	Factory setting: #. ##
Display address 0137										
⚡	10.08	4th Output Frequency (Low Frequency)	Control mode	VF	VFP	SVC	FOCPG	TQCPG	FOCPM	Factory setting: #. ##
Display address 0138										
⚡	10.09	4th Output Voltage (Low Voltage)	Control mode	VF	VFP	SVC	FOCPG	TQCPG	FOCPM	Factory setting: #. ##
Display address 0139										

- ↗ **10.10** Door Open Acceleration Time 1
Control mode **VF VFPG SVC FOC PG TQCPG FOC PM** Factory setting: #. ##
Display address 0408

- ↗ **10.11** Door Open Deceleration Time 1
Control mode **VF VFPG SVC FOC PG TQCPG FOC PM** Factory setting: #. ##
Display address 0409

- ↗ **10.12** Door Close Acceleration Time 2
Control mode **VF VFPG SVC FOC PG TQCPG FOC PM** Factory setting: #. ##
Display address 0508

- ↗ **10.13** Door Close Deceleration Time 2
Control mode **VF VFPG SVC FOC PG TQCPG FOC PM** Factory setting: #. ##
Display address 0509

- ↗ **10.14** Frequency Testing
Control mode **VF VFPG SVC FOC PG TQCPG FOC PM** Factory setting: #. ##
Display address 0015

- ↗ **10.15** Door Open Time by Initial Speed
Control mode **VF VFPG SVC FOC PG TQCPG FOC PM** Factory setting: #. ##
Display address 0402

- ↗ **10.16** Door Open by Initial Speed
Control mode **VF VFPG SVC FOC PG TQCPG FOC PM** Factory setting: #. ##
Display address 0400

- ↗ **10.17** Door Open High Speed
Control mode **VF VFPG SVC FOC PG TQCPG FOC PM** Factory setting: #. ##
Display address 0403

- ↗ **10.18** Door Open Final Speed
Control mode **VF VFPG SVC FOC PG TQCPG FOC PM** Factory setting: #. ##
Display address 0405

- ↗ **10.19** Door Open Holding Torque Level
Control mode **VF VFPG SVC FOC PG TQCPG FOC PM** Factory setting: #. ##
Display address 0410

↗	10.20	Door Open Holding Torque
Control mode	VF VFPG SVC FOCPG TQCPG FOCPM	Factory setting: #. ##
	Display address	0411
↗	10.21	Door Close High Speed
Control mode	VF VFPG SVC FOCPG TQCPG FOCPM	Factory setting: #. ##
	Display address	0503
↗	10.22	Door Close Final Speed
Control mode	VF VFPG SVC FOCPG TQCPG FOCPM	Factory setting: #. ##
	Display address	0505
↗	10.23	Door Close Holding Torque Level
Control mode	VF VFPG SVC FOCPG TQCPG FOCPM	Factory setting: #. ##
	Display address	0510
↗	10.24	Door Close Holding Torque
Control mode	VF VFPG SVC FOCPG TQCPG FOCPM	Factory setting: #. ##
	Display address	0511
↗	10.25	Multi-function Input Terminal Direction
Control mode	VF VFPG SVC FOCPG TQCPG FOCPM	Factory setting: #. ##
	Display address	0207
↗	10.26	Multi-function Input 1
Control mode	VF VFPG SVC FOCPG TQCPG FOCPM	Factory setting: #. ##
	Display address	0201
↗	10.27	Multi-function Input 2
Control mode	VF VFPG SVC FOCPG TQCPG FOCPM	Factory setting: #. ##
	Display address	0202
↗	10.28	Multi-function Input 3
Control mode	VF VFPG SVC FOCPG TQCPG FOCPM	Factory setting: #. ##
	Display address	0203
↗	10.29	Multi-function Input 4
Control mode	VF VFPG SVC FOCPG TQCPG FOCPM	Factory setting: #. ##
	Display address	0204

↗	1030	Multi-function Output RY1
Control mode	VF VFPG SVC FOC PG TQCPG FOC PM	Factory setting: #. ##
	Display address	0208
↗	1031	Multi-function Output RY2
Control mode	VF VFPG SVC FOC PG TQCPG FOC PM	Factory setting: #. ##
	Display address	0209

1000	~	View User-defined Parameters
1031		
Control mode	VF VFPG SVC FOC PG TQCPG FOC PM	Factory setting: #. ##
	Settings	-

📖 This parameter group is open for users to define parameters from group 00 to group 09, it can saves 32 parameters. The saved value can also be the parameter addresses (but the hexadecimal value needs to be converted to decimal value).

📖 How to set user-defined parameter:

Example 1:

On the digital keypad, enter Pr.10.00 and the setting is 0800, after the setting is complete, Pr.11-00 will display the setting of Pr.08-00. Please follow the diagram below for using the digital keypad.

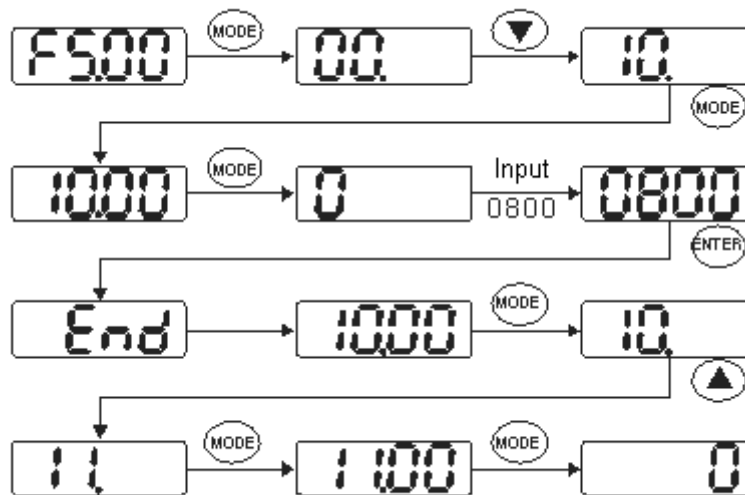

Example 2:

If it needs to enter the parameter address 2102H and 211BH by digital keypad, please follow the instruction shown on the diagram below.

The setting method of 2102H, please follow the steps shown in the diagram:

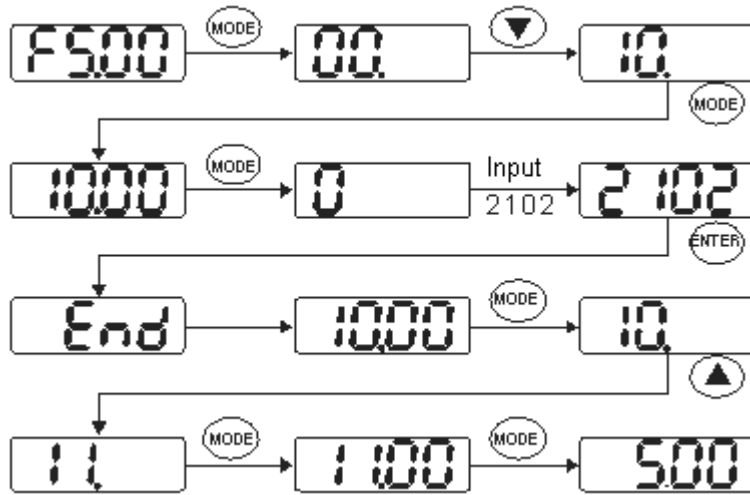

The setting method of 211BH

Convert 211BH (hexadecimal) into decimal value:

$$\begin{array}{c}
 2 \ 1 \ 1 \ B \\
 \swarrow \quad \searrow \\
 1 \times 16^1 + 11 \times 16^0 = 16 + 11 = 27
 \end{array}$$

Enter 2127

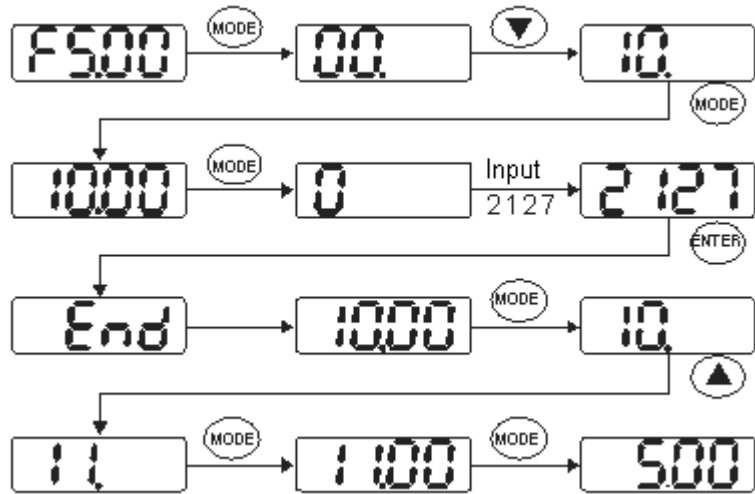

11 View User-defined Parameters

⚡ This parameter can be set during

operation.

1100

~

1131

View User-defined Parameters

Control mode **VF** **VFP**G **SVC** **FOCP**G **TQCP**G **FOCP**M

Factory setting: #. ##

Settings -

📖 Please refer to the parameter groups shown in group 10.

Chapter 5 Troubleshooting

- 5-1 Over Current (OC)
- 5-2 Ground Fault (GFF)
- 5-3 Over Voltage (OV)
- 5-4 Low Voltage (Lv)
- 5-5 Over Heat (OH1)
- 5-6 Overload (OL)
- 5-7 Digital Display is Abnormal
- 5-8 Phase Loss (PHL)
- 5-9 Motor does not Run
- 5-10 Fail to Adjust Motor Speed
- 5-11 Motor Stalls During Acceleration
- 5-12 Motor Run Error
- 5-13 Electromagnetic/Induction Noise
- 5-14 Environmental Condition
- 5-15 Prevent Interference to other Devices



- It is crucial for technician to properly inspect the machine to prevent incidents.

5-1 Over Current (oc)

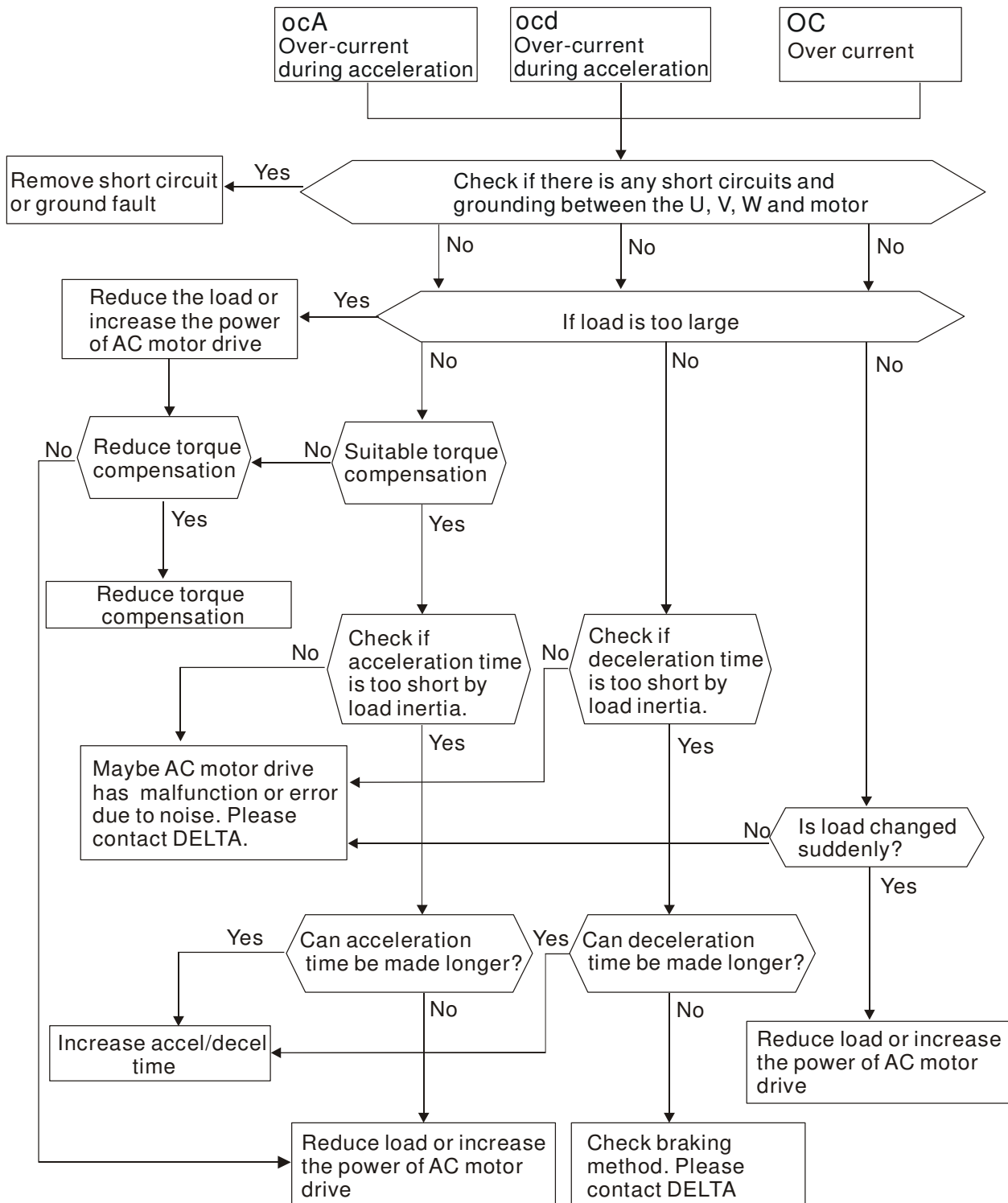

5-2 Ground Fault (GFF)

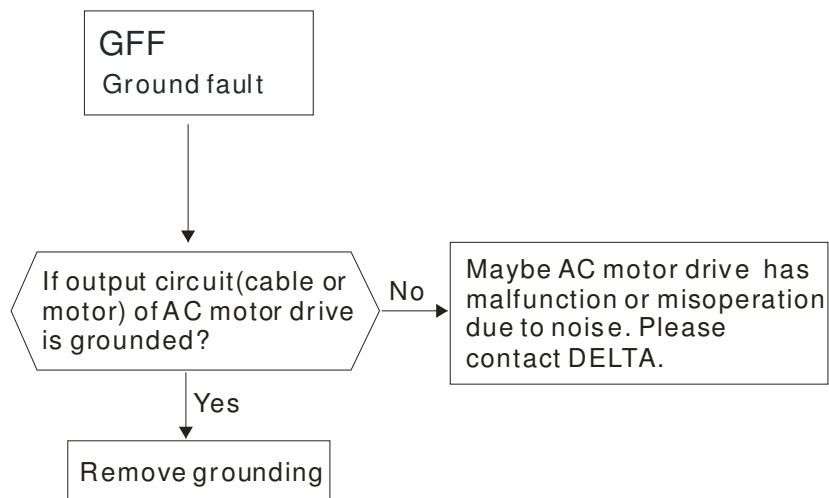

5-3 Over Voltage (ov)

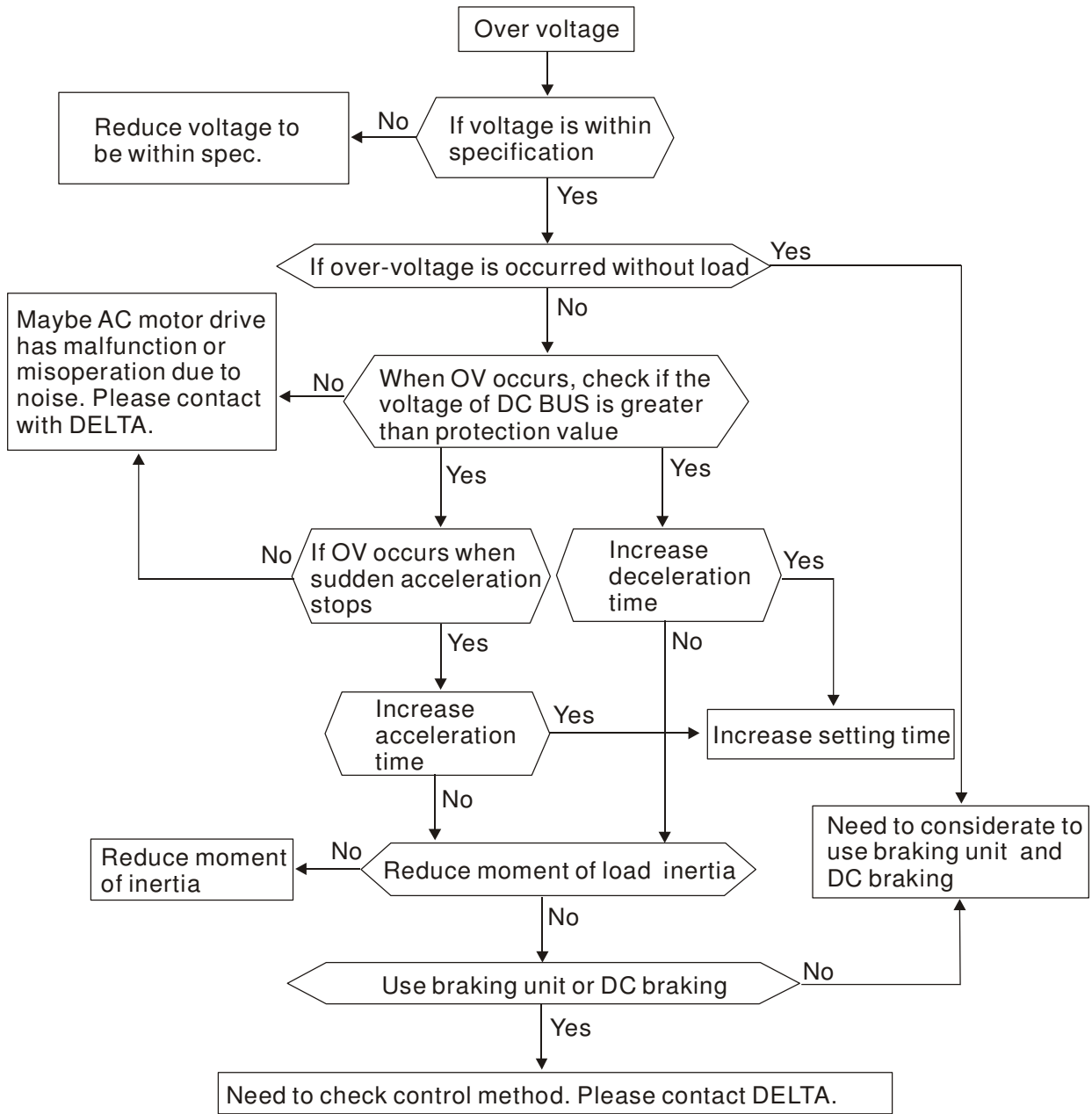

5-4 Low Voltage (Lv)

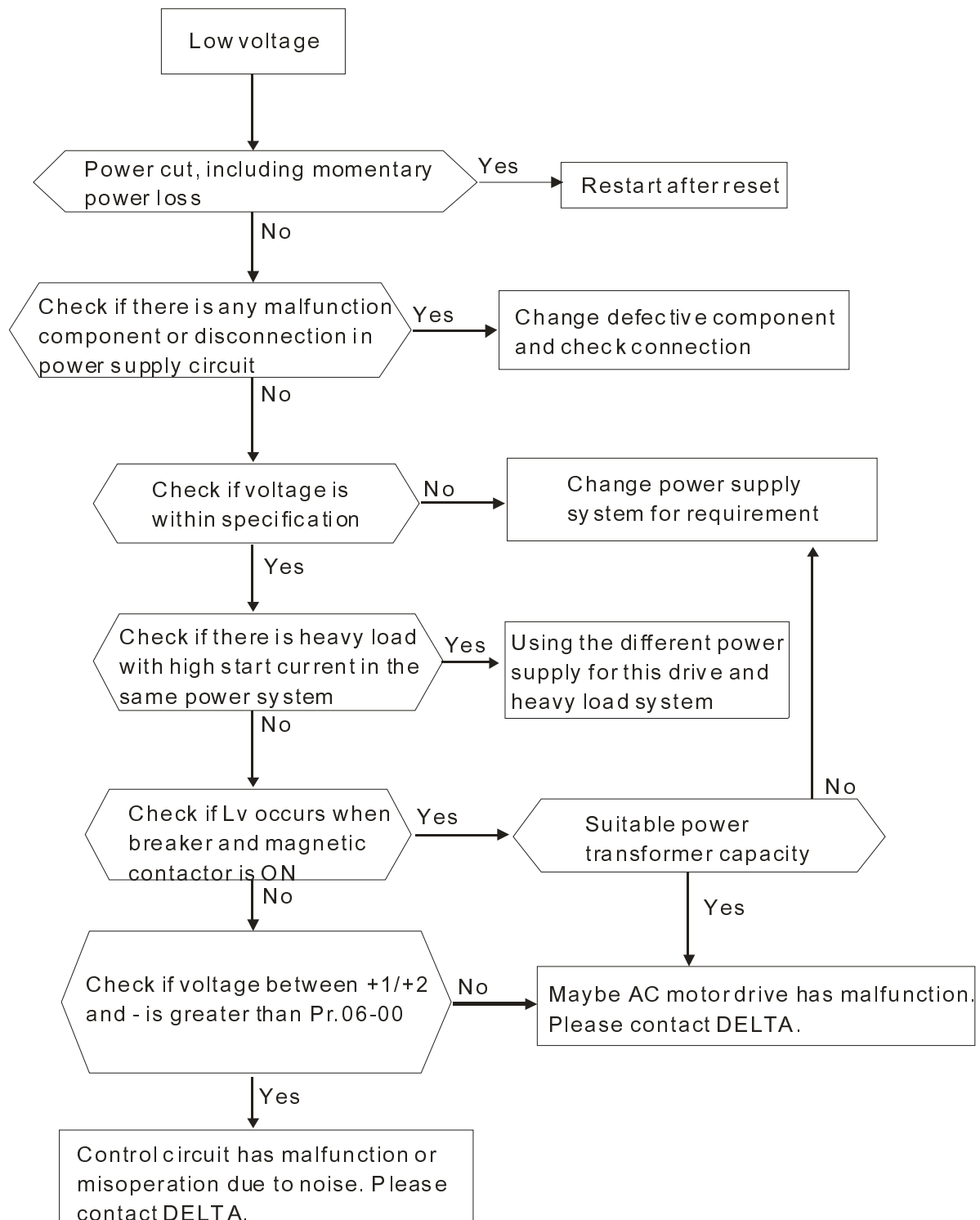

5-5 Over Heat (oH1)

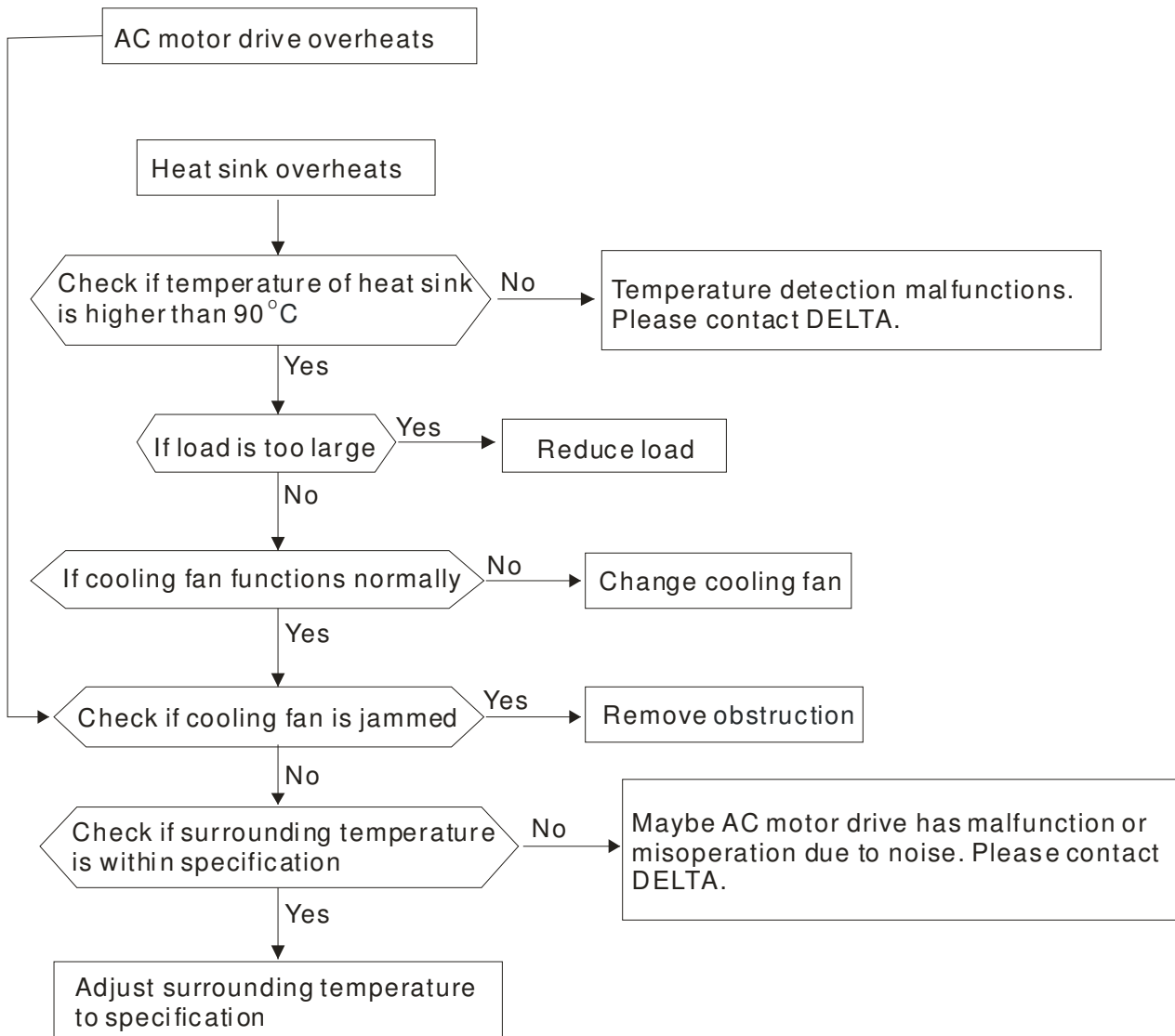

5-6 Overload (oL)

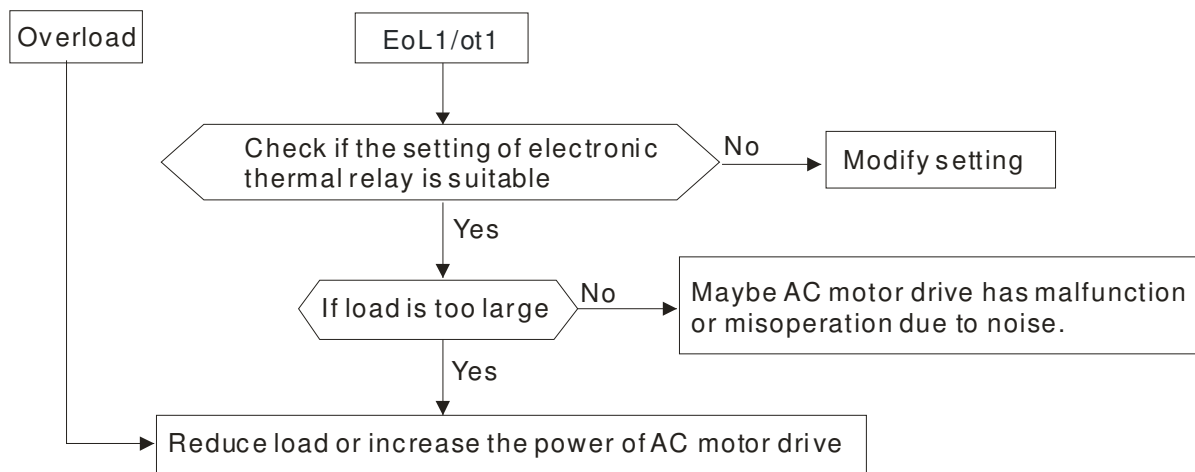

5-7 Digital Keypad Display is Abnormal

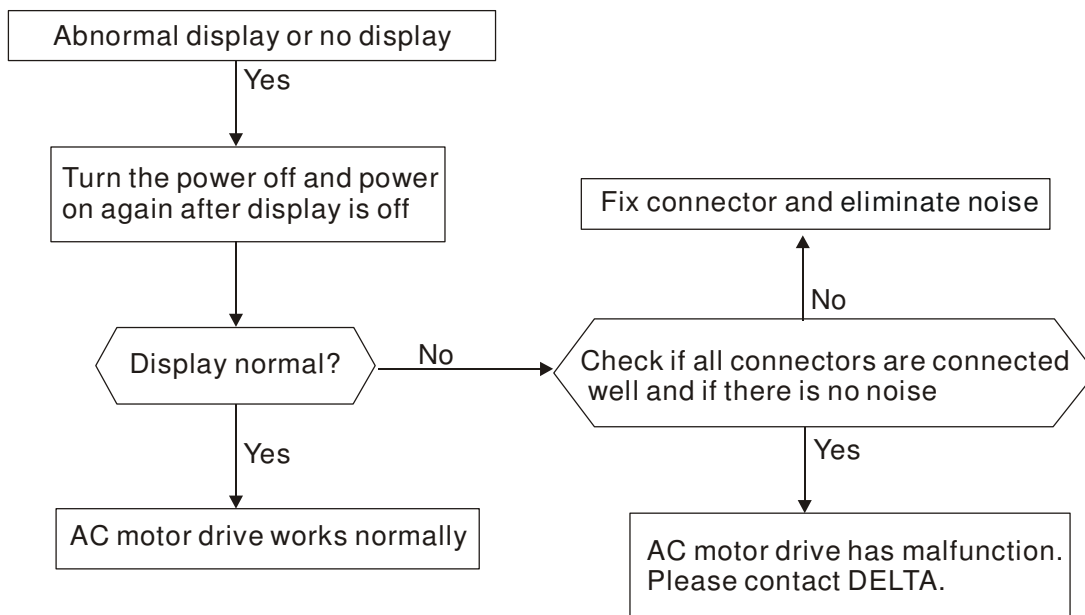

5-8 Phase Loss (PHL)

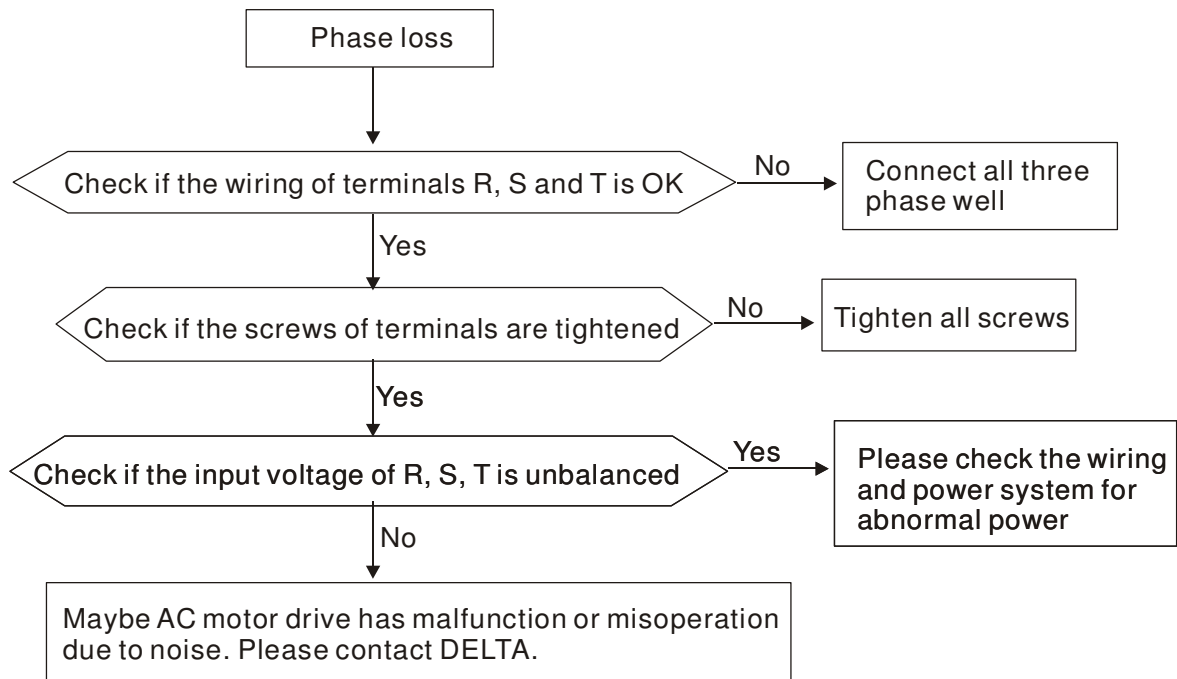

5-9 Motor does not Run

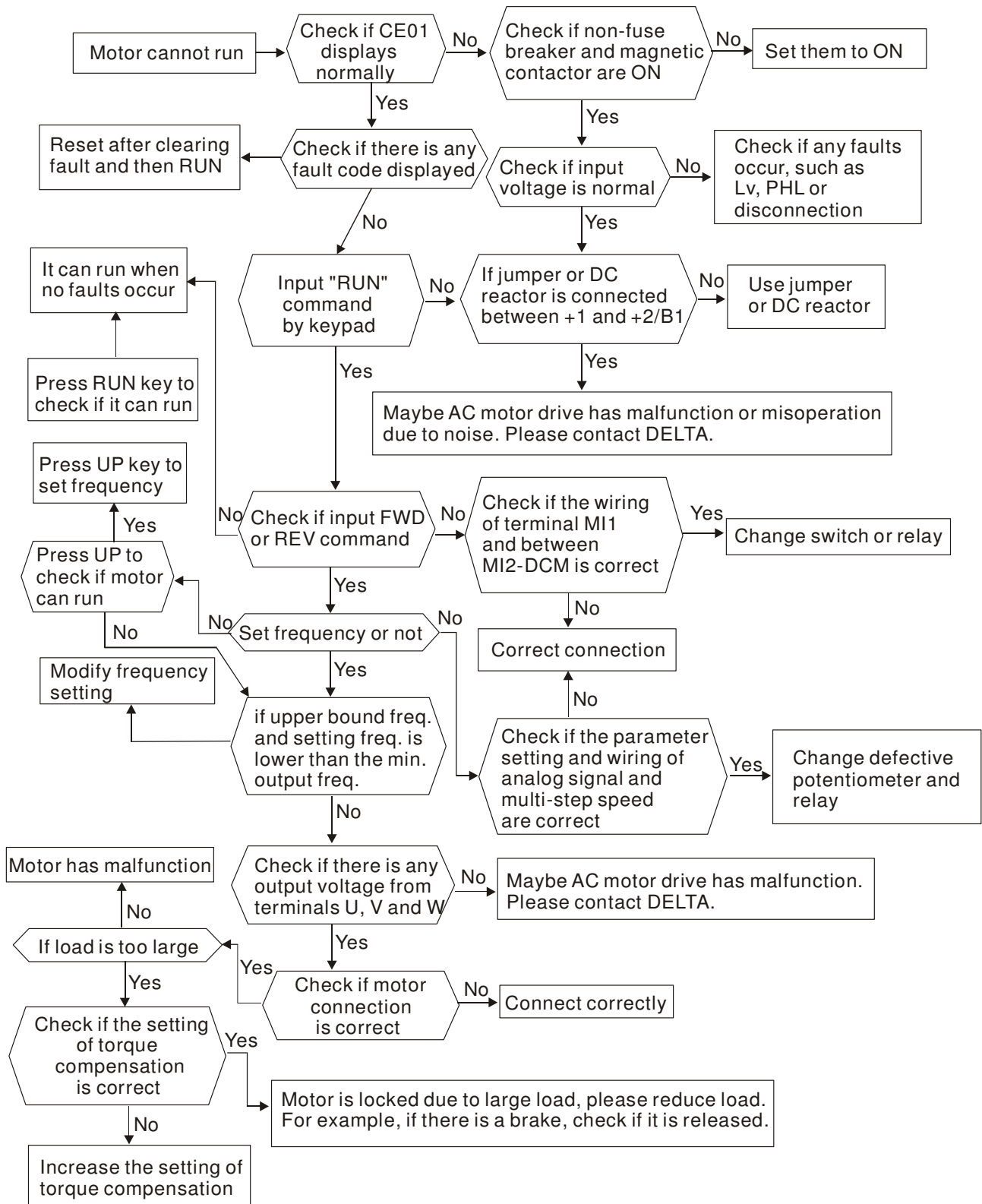

5-10 Fail to Adjust Motor Speed

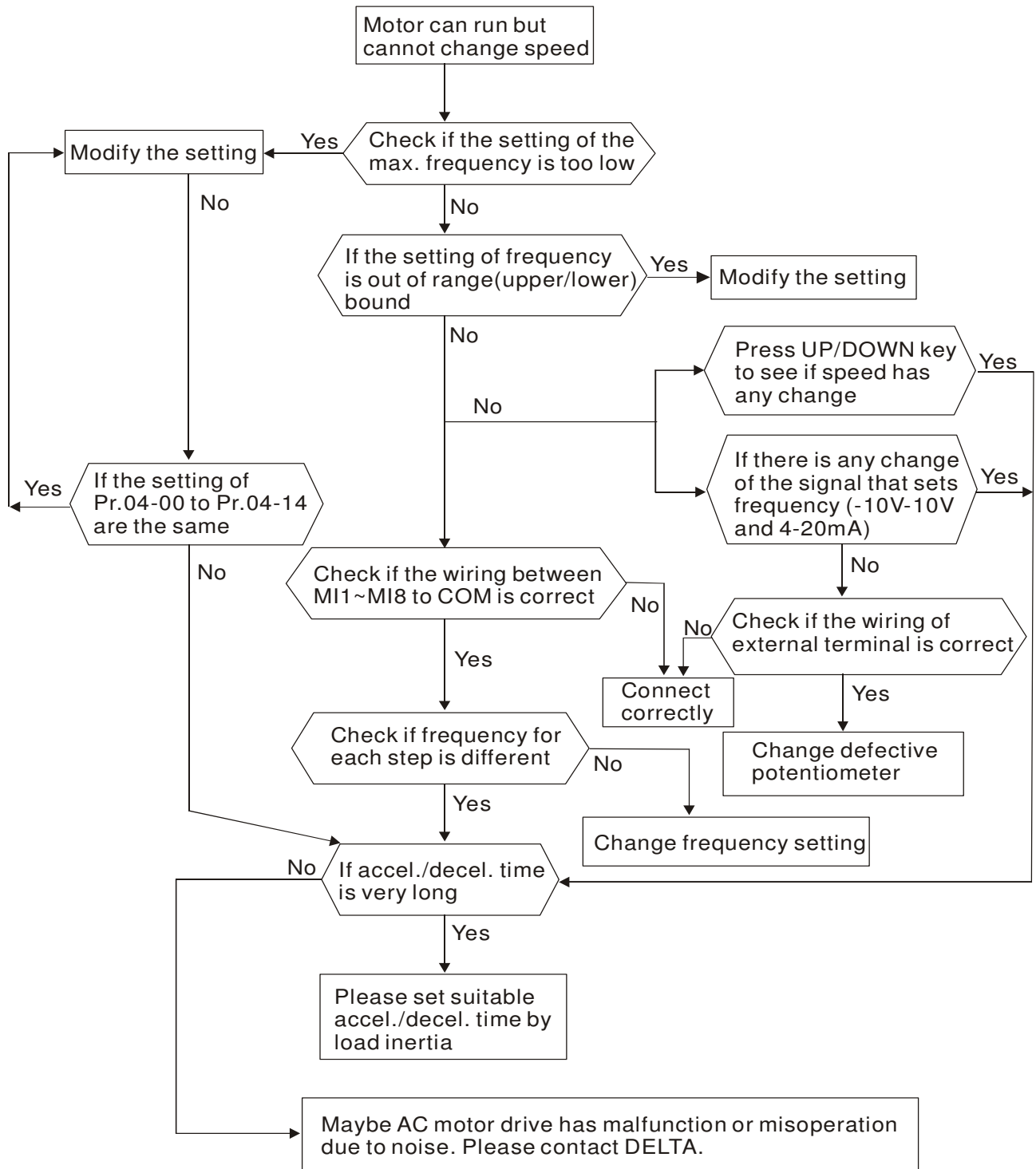

5-11 Motor Stalls during Acceleration

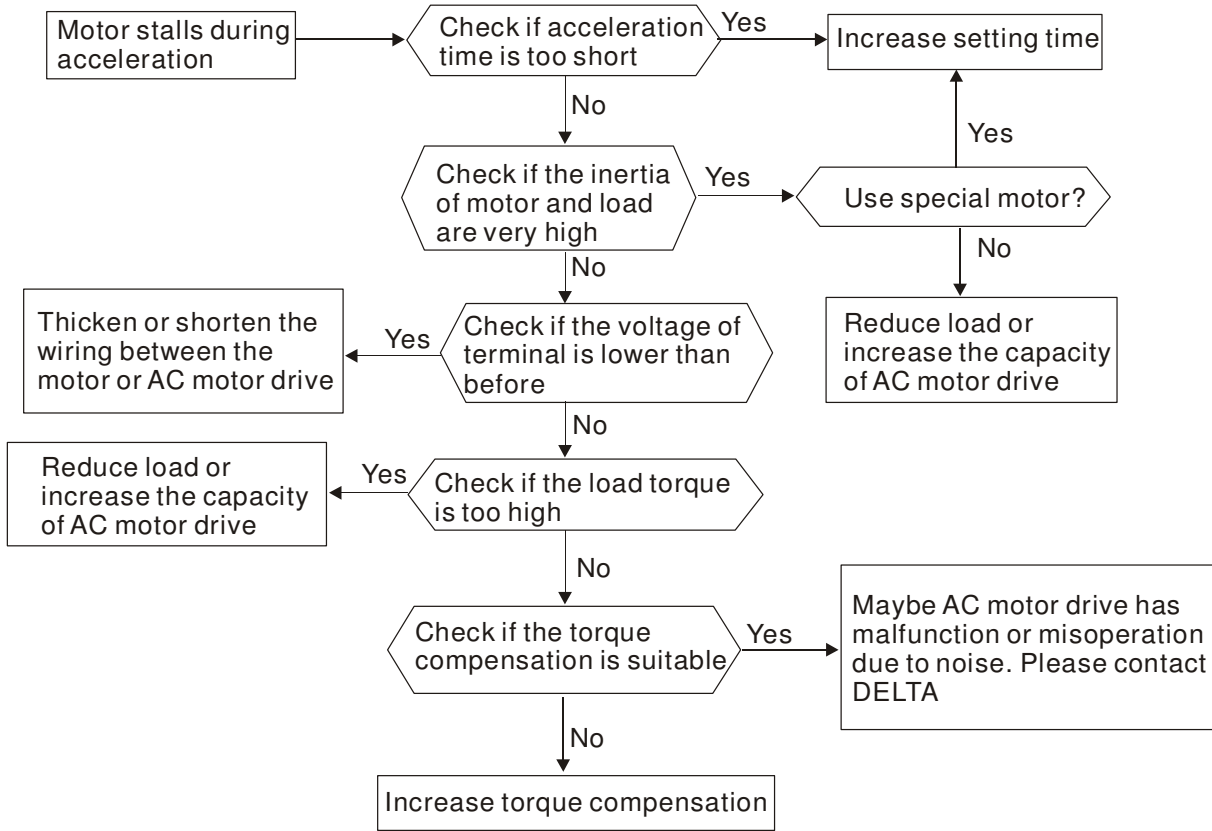

5-12 Motor Run Error

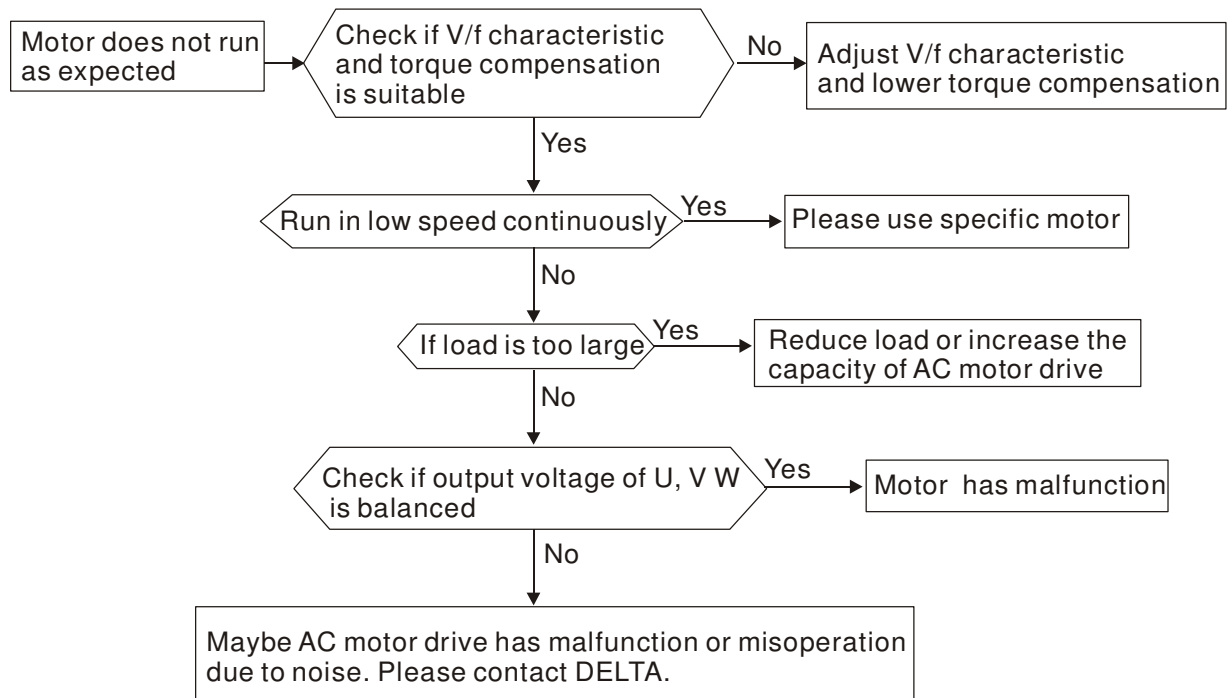

5-13 Electromagnetic/Induction Noise

There are many noises surround the AC motor drives and invade it by radiation or power circuit. It may cause the misoperation of control circuit and even damage the AC motor drive. Of course, that is a solution to increase the noise tolerance of AC motor drive. But it is not the best one due to the limit.

Therefore, solve it from the outside as following will be the best.

1. Add surge killer on the relay or contact to suppress switching surge between ON/OFF.
2. Shorten the wiring length of the control circuit or serial circuit and separate from the main circuit wiring.
3. Comply with the wiring regulation for those shielded wire and use isolation amplifier for long wire.
4. The grounding terminal should comply with the local regulation and ground independently, i.e. not to have common ground with electric welding machine and power equipment.
5. Connect a noise filter at the input terminal of the AC motor drive to prevent noise from power circuit.

In a word, three-level solutions for electromagnetic noise are “no product”, “no spread” and “no receive”.

5-14 Environmental Condition

Since AC motor drive is an electronic device, you should comply with the environmental condition stated in the appendix A. Following are the remedial measures for necessary.

6. To prevent vibration, anti-vibration spacer is the last choice. The vibration tolerance must be within the specification. The vibration effect is equal to the mechanical stress and it cannot occur frequently, continuously or repeatedly to prevent damaging AC motor drive.
7. Store in a clean and dry location free from corrosive fumes/dust to prevent rustiness, poor contact. It also may cause short by low insulation in a humid location. The solution is to use both paint and dust-proof. For particular occasion, use the enclosure with whole-seal structure.
8. The surrounding temperature should be within the specification. Too high or low temperature will affect the lifetime and reliability. For semiconductor components, damage will occur once any specification is out of range. Therefore, it is necessary to clean and periodical check for the air cleaner and cooling fan besides having cooler and sunshade. In additional, the microcomputer may not work in extreme low temperature and needs to have heater.
9. Store within a relative humidity range of 0% to 90% and non-condensing environment. Do not turn off the air conditioner and have exsiccator for it.

5-15 Prevent Interfere to Other Machines

AC motor drive may affect the operation of other machine due to many reasons. The solutions are as follows.

High Harmonic at Power Side

If there is high harmonic at power side during running, the improved methods are:

1. Separate power system: use transformer for AC motor drive.
2. Use reactor at the power input terminal of AC motor drive or decrease high harmonic by multiple circuit.
3. If there is phase lead capacitor, it should use serial reactor to prevent capacitor damage from high harmonic.

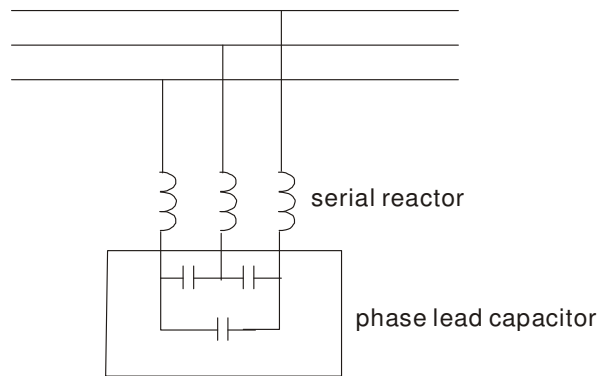

Motor Temperature Rises

When the motor is induction motor with ventilation-cooling-type used in variety speed operation, bad cooling will happen in the low speed. Therefore, it may overheat. Besides, high harmonic is in output waveform to increase copper loss and iron loss. Following measures should be used by load situation and operation range when necessary.

1. Use the motor with independent power ventilation or increase the horsepower.
2. Use inverter duty motor.
3. Do NOT run in the low speed

Chapter 6 Fault Codes and Descriptions

6-1 Common Problems and Solutions

6-2 Maintenance and Inspections

The AC motor drive has a comprehensive fault diagnostic system that includes several different alarms and fault messages. Once a fault is detected, the corresponding protective functions will be activated. The following faults are displayed as shown on the AC motor drive digital keypad display. The six most recent faults can be read from the digital keypad or communication.

The AC motor drive is made up by numerous components, such as electronic components, including IC, resistor, capacity, transistor, and cooling fan, relay, etc. These components can't be used permanently. They have limited-life even under normal operation. Preventive maintenance is required to operate this AC motor drive in its optimal condition, and to ensure a long life.









Basic check-up items to detect if there were any abnormalities during operation are:



























- ☑ Wait 5 seconds after a fault has been cleared before performing reset via keypad of input terminal.
- ☑ When the power is off after 5 minutes for $\leq 22\text{kW}$ models and 10 minutes for $\geq 30\text{kW}$ models, please confirm that the capacitors have fully discharged by measuring the voltage between DC+ and DC-. The voltage between DC+ and DC- should be less than 25VDC.
- ☑ Only qualified personnel can install, wire and maintain AC motor drives. Do not wear any metallic accessory such as watches or rings when installing the drives. Please use proper insulated tools only.
- ☑ Never reassemble internal components or wiring.
- ☑ Make sure that installation environment comply with regulations without abnormal noise, vibration and smell.

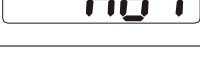







6-1 Common Problems and Solutions



Following fault name will only be displayed when using the digital keypad.

Display	Description	Corrective Actions
	Over-current during acceleration (Output current exceeds triple rated current during acceleration.)	<ol style="list-style-type: none"> 1. Short-circuit at motor output: Check for possible poor insulation at the output. 2. Acceleration Time too short: Increase the Acceleration Time. 3. AC motor drive output power is too small: Replace the AC motor drive with the next higher power model.
	Over-current during deceleration (Output current exceeds triple rated current during deceleration.)	<ol style="list-style-type: none"> 1. Short-circuit at motor output: Check for possible poor insulation at the output. 2. Deceleration Time too short: Increase the Deceleration Time. 3. AC motor drive output power is too small: Replace the AC motor drive with the next higher power model.
	Over-current during steady state operation (Output current exceeds triple rated current during constant speed.)	<ol style="list-style-type: none"> 1. Short-circuit at motor output: Check for possible poor insulation at the output. 2. Check if motor is jammed. 3. AC motor drive output power is too small: Replace the AC motor drive with the next higher power model.
	Short-circuit is detected between upper bridge and lower bridge of the IGBT module	Return to the factory
	Hardware failure in current detection Over current occur at STOP	Return to the factory
	DC BUS over-voltage during acceleration (230V: DC 450V; 460V: DC 810V)	<ol style="list-style-type: none"> 1. Check if the input voltage falls within the rated AC motor drive input voltage range. 2. Check for possible voltage transients. 3. If DC BUS over-voltage due to regenerative voltage, please increase the Deceleration Time or add an optional brake resistor.
	DC BUS over-voltage during deceleration (230V: DC 405V; 460V: DC 810V)	
	DC BUS over-voltage at constant speed (230V: DC 405V; 460V: DC 810V)	

Display	Description	Corrective Actions
	Hardware failure in voltage detection	<ol style="list-style-type: none"> 1. Check if the input voltage falls within the rated AC motor drive input voltage range. 2. Check for possible voltage transients.
	DC BUS voltage is less than Pr.06-00 during acceleration	<ol style="list-style-type: none"> 1. Check if the input voltage is normal 2. Check for possible sudden load
	DC BUS voltage is less than Pr.06-00 during deceleration	<ol style="list-style-type: none"> 1. Check if the input voltage is normal 2. Check for possible sudden load
	DC BUS voltage is less than Pr.06-00 in constant speed	<ol style="list-style-type: none"> 1. Check if the input voltage is normal 2. Check for possible sudden load
	DC BUS voltage is less than Pr.06-00 at stop	<ol style="list-style-type: none"> 1. Check if the input voltage is normal 2. Check for possible sudden load
	Phase Loss	Check Power Source Input if all 3 input phases are connected without loose contacts.
	<p>IGBT overheating</p> <p>IGBT temperature exceeds protection level</p> <p>1~30HP: 100°C</p>	<ol style="list-style-type: none"> 1. Ensure that the ambient temperature falls within the specified temperature range. 2. Make sure the ventilation holes are not obstructed and fan is spinning freely. 3. AC motor drive should be placed in a good ventilation space.
	<p>Overload</p> <p>The AC motor drive detects excessive drive output current. The drive can handle rated output current 150% for a maximum 60 seconds.</p>	<ol style="list-style-type: none"> 1. Check if the motor is overloaded. 2. Take the next higher power AC motor drive model.
	Motor 1 Overload	<ol style="list-style-type: none"> 1. Check if motor 1 is overloaded. 2. Check the motor's rated current (Pr.05-01). 3. Increase motor capacity
	Internal EEPROM can not be programmed.	Use the RESET key to reset all parameters to factory settings, if it does not work, please return it to the factory.
	Internal EEPROM can not be read.	

Display	Description	Corrective Actions
	Hardware failure in current detection (Isum)	Re-apply power and try again. If fault still occurs, please return it to the factory.
	U-phase error	
	V-phase error	
	W-phase error	
	CC current clamp	Re-apply power and try again. If fault still occurs, please return it to the factory.
	OC hardware error	
	OV hardware error	
	Auto tuning error	<ol style="list-style-type: none"> 1. Check cabling between drive and motor 2. Check the motor capacity and parameters settings 3. Retry again
	PG feedback error	When the setting is in PG feedback control mode, check if the value of Pr.10-01 is not 0.
	PG feedback loss	Check the wiring of PG feedback.
	PG feedback stall	<ol style="list-style-type: none"> 1. Check the wiring of the PG feedback 2. Check if the setting of PI gain and deceleration is suitable
	PG slip error	<ol style="list-style-type: none"> 3. Return to the factory
	External fault	<ol style="list-style-type: none"> 1. When external terminal EF is closed (N.O), the AC motor drive will stop output. 2. After fault is cleared, press RESET.

Display	Description	Corrective Actions
	Emergency stop	<ol style="list-style-type: none"> When multi-function input terminals MI1~MI6 are set to emergency stop, the AC motor drive will stop output. After fault is cleared, press RESET.
	Password is locked	<ol style="list-style-type: none"> Keypad will be locked after three wrong password inputs. Please refer to the setting in Pr.00-07 and Pr.00-08. Re-apply the power and input the right password.
	Illegal communication code	Check if the communication code is correct (function code must be 03, 06, 10, 63)
	Illegal data length	Check if the communication data length is correct (00H~254H).
	Illegal data value	Check if the data value exceeds its minimum and maximum value.
	Illegal communication address	Check if the communication address is correct.
	<p>Communication time-out</p> <p>It occurs when COM1 communication time-out exceeds Pr.09-03 or when COM2 communication time-out exceeds Pr. 09-07</p>	Check if the wiring for the communication is correct.
	<p>Keypad (KPV-CE01) communication time-out</p> <p>It occurs when the source command is digital keypad, and COM1 communication time-out exceeds Pr.09-03 and COM2 communication time-out exceeds Pr.09-07</p>	<ol style="list-style-type: none"> Check if the wiring for the communication is correct Check if there is any wrong with the keypad

Display	Description	Corrective Actions
	Door width auto-tuning error	Check the wiring of the encoder
	Open door time-out	Check if door opens fluently.

6.1.1 Reset

There are three methods to reset the AC motor drive after the fault is corrected:

1. Press  key on KPV-CE01.
2. Set external terminal to “RESET” and then set the contact ON.
3. Send “RESET” command by communication.

NOTE

Make sure that RUN command or signal is OFF before executing RESET to prevent damage or personal injury due to immediate operation.

6.2 Maintenance and Inspections

Before the check-up, always turn off the AC input power and remove the cover. Wait at least 10 minutes after all display lamps have gone out, and then confirm that the capacitors have fully discharged by measuring the voltage between DC+ and DC-. The voltage between DC+ and DC- should be less than 25VDC.

■ Ambient environment

Check Items	Methods and Criterion	Maintenance Period		
		Daily	Half Year	One Year
Check the ambient temperature, humidity, vibration and see if there are any dust, gas, oil or water drops	Visual inspection and measurement with equipment with standard specification	○		
If there are any dangerous objects	Visual inspection	○		

■ Voltage

Check Items	Methods and Criterion	Maintenance Period		
		Daily	Half Year	One Year
Check if the voltage of main circuit and control circuit is correct	Measure with multimeter with standard specification	○		

■ Keypad

Check Items	Methods and Criterion	Maintenance Period		
		Daily	Half Year	One Year
Is the display clear for reading	Visual inspection	○		
Any missing characters	Visual inspection	○		

■ Mechanical parts

Check Items	Methods and Criterion	Maintenance Period		
		Daily	Half Year	One Year
If there is any abnormal sound or vibration	Visual and aural inspection		○	
If there are any loose screws	Tighten the screws		○	

Check Items	Methods and Criterion	Maintenance Period		
		Daily	Half Year	One Year
If any part is deformed or damaged	Visual inspection		○	
If there is any color change by overheating	Visual inspection		○	
If there is any dust or dirt	Visual inspection		○	

■ **Main circuit**

Check Items	Methods and Criterion	Maintenance Period		
		Daily	Half Year	One Year
If there are any loose or missing screws	Tighten or replace the screw	○		
If machine or insulator is deformed, cracked, damaged or with color change due to overheating or ageing	Visual inspection NOTE: Please ignore the color change of copper plate		○	
If there is any dust or dirt	Visual inspection		○	

■ **Terminals and wiring of main circuit**

Check Items	Methods and Criterion	Maintenance Period		
		Daily	Half Year	One Year
If the terminal or the plate is color change or deformation due to overheat	Visual inspection		○	
If the insulator of wiring is damaged or color change	Visual inspection		○	
If there is any damage	Visual inspection	○		

■ **DC capacity of main circuit**

Check Items	Methods and Criterion	Maintenance Period		
		Daily	Half Year	One Year
If there is any leak of liquid, color change, crack or deformation	Visual inspection	○		
If the safety valve is not removed? If valve is inflated?	Visual inspection	○		
Measure static capacity when required		○		

■ **Resistor of main circuit**

Check Items	Methods and Criterion	Maintenance Period		
		Daily	Half Year	One Year
If there is any peculiar smell or insulator cracks due to overheat	Visual inspection, smell	○		
If there is any disconnection	Visual inspection	○		
If connection is damaged?	Measure with multimeter with standard specification	○		

■ **Transformer and reactor of main circuit**

Check Items	Methods and Criterion	Maintenance Period		
		Daily	Half Year	One Year
If there is any abnormal vibration or peculiar smell	Visual, aural inspection and smell	○		

■ **Magnetic contactor and relay of main circuit**

Check Items	Methods and Criterion	Maintenance Period		
		Daily	Half Year	One Year
If there are any loose screws	Visual and aural inspection	○		
If the contact works correctly	Visual inspection	○		

■ **Printed circuit board and connector of main circuit**

Check Items	Methods and Criterion	Maintenance Period		
		Daily	Half Year	One Year
If there are any loose screws and connectors	Tighten the screws and press the connectors firmly in place.		○	
If there is any peculiar smell and color change	Visual and smell inspection		○	
If there is any crack, damage, deformation or corrosion	Visual inspection		○	
If there is any liquid is leaked or deformation in capacity	Visual inspection		○	

■ **Cooling fan of cooling system**

Check Items	Methods and Criterion	Maintenance Period		
		Daily	Half Year	One Year
If there is any abnormal sound or vibration	Visual, aural inspection and turn the fan with hand (turn off the power before operation) to see if it rotates smoothly		○	
If there is any loose screw	Tighten the screw		○	
If there is any color change due to overheat	Change fan		○	

■ **Ventilation channel of cooling system**

Check Items	Methods and Criterion	Maintenance Period		
		Daily	Half Year	One Year
If there is any obstruction in the heat sink, air intake or air outlet	Visual inspection		○	

 **NOTE**

Please use the neutral cloth for clean and use dust cleaner to remove dust when necessary.

Appendix A Specifications

Drive Specifications

Model VFD-___DD		002	004
Applicable Motor Output(W)		200	400
Output Rating	Rated Output Capacity (kVA)	0.6	1.0
	Rated Output Current (A)	1.5	2.5
	Maximum Output Voltage (V)	Proportional to Input Voltage	
	Output Frequency (Hz)	0.00~120.00Hz	
	Carrier Frequency (kHz)	10 kHz	
	Rated Input Current (A)	4.9A	6.5A
Input Rating	Voltage Tolerance	Single phase 200 –20% ~ 240V +10% (160~264V)	
	Frequency Tolerance	50/60Hz ±5% (47~63Hz)	
Cooling Method		200W natural cool /400W natural cool	
Frame Size		W170mm*L215*H55mm	

Common Characteristics

Control Characteristics	Control Method		1: V/F, 2: VF+PG, 3: SVC, 4: FOC+PG, 6:PM FOC+PG
	Starting Torque		Starting torque at 0.5Hz is more than 150%, at 0 Hz is FOC+PG control mode
	Speed Control Range		1:100(external PG installation can achieve 1:1000)
	Speed Control Accuracy		±0.5% (external PG installation can achieve ±0.02%)
	Speed Response Ability		5Hz (vector control can attain 30Hz)
	Max. Output Frequency (Hz)		0.00 to 120.00 Hz
	Output Frequency Accuracy		Digital command ±0.005%
	Frequency Setting Resolution		Digital command ±0.01Hz
	Torque Limit		200% torque current as maximum
	Accel/Decel Time		0.00~600.00 sec
	V/F Curve Pattern		Adjustable V/F curve of 4 independent points
	Brake Torque		Approximately 10% (optional)
Operating Characteristics	Frequency Setting Signal	Keypad	By parameter setting
		External Signal	Multi-function input selection 1~5 (15 step speeds; JOG), parameter setting on serial communication port (RS-485)
	Operation Setting Signal	Keypad	Set by RUN, STOP key
		External Signal	2 wires (Fwd, Rev, RUN), JOG operation, RS-485 serial interface, demo mode
Multi-Function Input Signal		Multi-step speed selection MI1~MI15, Jog, first to second accel/decel switches, demo mode, force stop, emergency stop, operation command source, parameter lock, driver reset, open/close limit signal, door open prohibited signal, force open signal, reposition, 2nd step open/close curve selection	

	Multi-Function Output Signal	(RC1,RA1,RB1) , (RC2,RA2,RB2) ,(MO1,MO2,MO3 and MCM) AC drive operating, frequency attained, fault indication, over torque, over voltage, operation mode, alarm indication, demo mode indication, overheat alarm, drive is ready, emergency stop, braking signal, zero speed indication, PG indication error, position detection, limit signal, re-open/close indication, position finished
	Communication Interface	Built-in MODBUS, customize CAN Bus
	Alarm Output Contact	Contact "ON" when malfunctions occurs (relay with a "C" or "A" contact, or 2 open collector outputs)
	Operation Function	AVR, 4 set fault records, reverse inhibition, DC brake, auto torque/slip compensation, auto tuning, adjustable carrier frequency, output frequency upper and lower limits, parameter reset, vector control, MODBUS communication, abnormal reset, abnormal re-start, PG feedback control, fan control, demo mode, door width auto-tuning
	Protection Function	Over voltage, over current, under current, external fault, overload, ground fault, overload, overheating, electronic thermal, PG feedback error, external limit signal error, re-open/re-close
	Digital Keypad	7 function keys, 4-digit 7-segment LED, 4 status LEDs, master frequency, output frequency, output current, custom units, parameter values for setup, review and faults, RUN, STOP, RESET, FWD/REV
Protection Characteristics	Motor Protection	Electronic thermal relay protection
	Over Current Protection	The current forces 220% of the over-current protection and 300% of the rated current
	Overload Capacity	150% for 60 seconds; 180% for 10 seconds
	Voltage Protection	Over-voltage level: $V_{dc} > 400$; low-voltage level: $V_{dc} < 200$
	Over-voltage Protection for Input Power	Varistor (MOV)
	Overheat Protection	Built-in temperature sensor
Environment	Enclosure Rating	IP20
	Operation Temperature	-10°C ~ 40°C
	Ambient Temperature	-20°C ~ 60°C
	Ambient Humidity	Below 90% RH (non-condensing)
	Vibration	1.0G less than 20Hz, 0.6G at 20~60 Hz
	Installation Location	Altitude 1,000m or lower, keep from corrosive gasses, liquid and dust
Approval		UL(2011Q2),  (IEC 61800-3)

Motor Specifications

Maximum speed: 240 RPM; Poles number: 8 pairs (16 poles)

Frame		ECMD-B9120GMS	ECMD-B9160GMS
Rated Specifications	Rated Output Power (W)	70	65
	Rated Voltage (V)	230	220
	Rated Torque (N-m)	1.9	2.5
	Rated Speed (rpm)	350	250
	Rated Current (A)	0.84	1.0
Motor Specifications	Continuous Stall Torque (N-m)	1.9	2.5
	Maximum Momentary Torque(N-m)	3.0	3.0
	Maximum Speed (rpm)	750	300
	Maximum Momentary Current (A)	1.5	3.8
	Incitation Voltage Constant (mV/rpm)	99	100.8
	Constant Torque (N.m/A)	2.26	2.5
	Rotor Moment of Inertia (kg.m ²)	3.0*10 ⁻⁴	4.93*10 ⁻⁴
	Armature Resistance (Ohm)	16.8	13.95
	Armature Inductance (mH)	TBD	169.4
	Mechanical Time Constant (ms)	TBD	2.86
	Electrical Time Constant (ms)	TBD	12.14
	Insulation Class	B	B
	Insulation Resistance	10MΩDC500V	10MΩDC500V
	Insulation Strength	1.5kVAC, 1min.	1.5kVAC, 1min.
	Max. Radial Shaft Load (N)	98	98
	Max. Thrust Shaft Load (N)	49	49
Weight (kg)	2.5	3.0	
Environment Specifications	Maximum Winding Temperature	130°C	130°C
	Operating Temperature	5~45°C	5~45°C
	Storage Temperature	-10~50°C	-10~50°C
	Operating Humidity (%RH)	20~95%RH(non-condensing)	20~95%RH(non-condensing)
	Storage Humidity(%RH)	20~95%RH(non-condensing)	20~95%RH(non-condensing)
	IP Rating	IP20(Standard)	

Motor Model

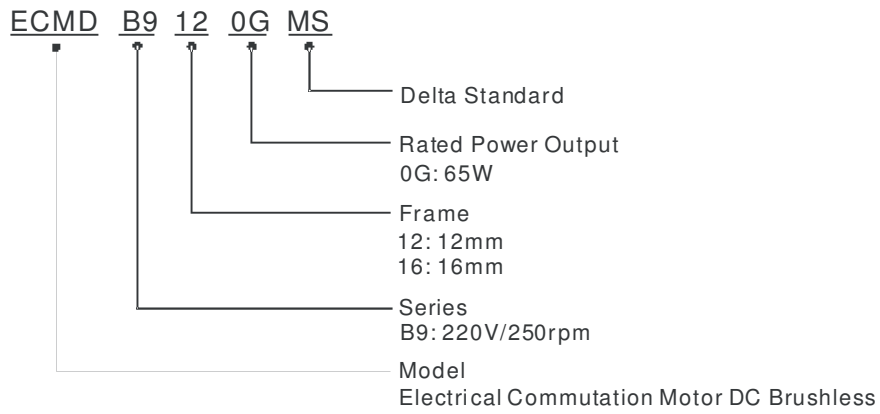

Encoder for Motor

ENCODER OUTPUT

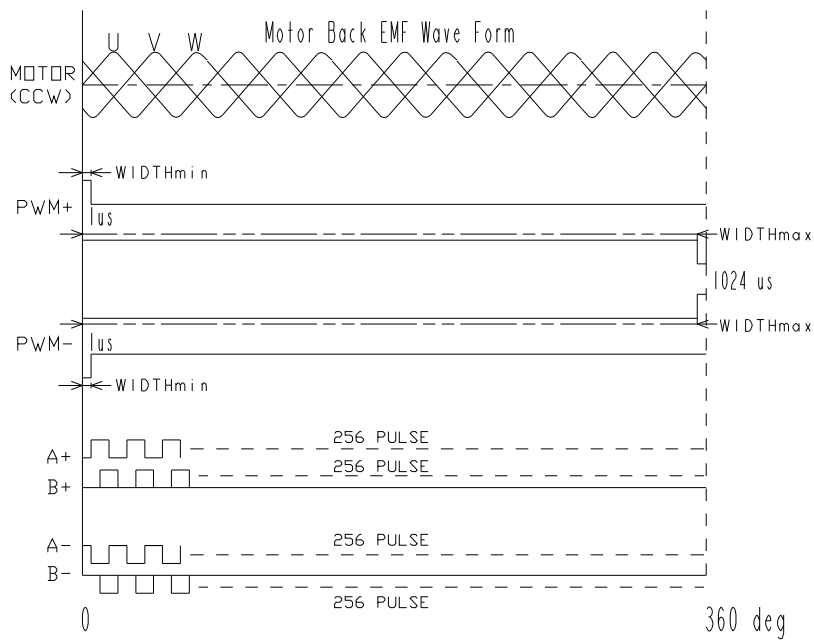

Phase Relation between Motor and Encoder
 (CCW, View from Shaft End)

Appendix B

How to Select an AC Motor Drive

B-1 Capacity Calculation

B-2 General Precautions

B-3 How to Choose a Suitable Motor

The choice of the right AC motor drive for the application is very important and has great influence on its lifetime. If the capacity of AC motor drive is too large, it cannot offer complete protection to the motor and motor maybe damaged. If the capacity of AC motor drive is too small, it cannot offer the required performance and the AC motor drive maybe damaged due to overloading.

But by simply selecting the AC motor drive of the same capacity as the motor, user application requirements cannot be met completely. Therefore, a designer should consider all the conditions, including load type, load speed, load characteristic, operation method, rated output, rated speed, power and the change of load capacity. The following table lists the factors you need to consider, depending on your requirements.

Item		Related Specification			
		Speed and torque characteristics	Time ratings	Overload capacity	Starting torque
Load type	Friction load and weight load; Liquid (viscous) load; Inertia load; Load with power transmission	•			•
Load speed and torque characteristics	Constant torque; Constant output; Decreasing torque; Decreasing output	•	•		
Load characteristics	Constant load; Shock load; Repetitive load; High starting torque Low starting torque	•	•	•	•
Operation Method	Continuous operation; Short-time operation; Long-time operation at medium/low speeds		•	•	
Rated Output	Maximum output current (instantaneous); Constant output current (continuous)	•		•	
Rated Speed	Maximum frequency; Base frequency	•			
Input Power	Power supply transformer capacity; Percentage impedance; Voltage fluctuations and unbalance Number of phases; Single phase protection; Frequency			•	•
Load Capacity Changes	Mechanical friction; Losses in wiring			•	•
	Duty cycle modification		•		

B-1 Capacity Calculation

1. When one AC motor drive operates one motor

The starting capacity should be less than 1.5x rated capacity of AC motor drive

The starting capacity=

$$\frac{k \times N}{973 \times \eta \times \cos \varphi} \left(T_L + \frac{GD^2}{375} \times \frac{N}{t_A} \right) \leq 1.5 \times \text{the_capacity_of_AC_motor_drive(kVA)}$$

2. When one AC motor drive operates more than one motor

2.1 The starting capacity should be less than the rated capacity of AC motor drive

- Acceleration time ≤ 60 seconds

The starting capacity=

$$\frac{k \times N}{\eta \times \cos \varphi} [n_r + n_s(k_s - 1)] = P_{C1} \left[1 + \frac{n_s}{n_r} (k_s - 1) \right] \leq 1.5 \times \text{the_capacity_of_AC_motor_drive(kVA)}$$

- Acceleration time ≥ 60 seconds

The starting capacity=

$$\frac{k \times N}{\eta \times \cos \varphi} [n_r + n_s(k_s - 1)] = P_{C1} \left[1 + \frac{n_s}{n_r} (k_s - 1) \right] \leq \text{the_capacity_of_AC_motor_drive(kVA)}$$

2.2 The current should be less than the rated current of AC motor drive (A)

- Acceleration time ≤ 60 seconds

$$n_r + I_M \left[1 + \frac{n_s}{n_r} (k_s - 1) \right] \leq 1.5 \times \text{the_rated_current_of_AC_motor_drive(A)}$$

- Acceleration time ≥ 60 seconds

$$n_r + I_M \left[1 + \frac{n_s}{n_r} (k_s - 1) \right] \leq \text{the_rated_current_of_AC_motor_drive(A)}$$

2.3 When it is running continuously

- The requirement of load capacity should be less than the capacity of AC motor drive(kVA)
 The requirement of load capacity=

$$\frac{k \times P_M}{\eta \times \cos \varphi} \leq \text{the_capacity_of_AC_motor_drive(kVA)}$$

- The motor capacity should be less than the capacity of AC motor drive

$$k \times \sqrt{3} \times V_M \times I_M \times 10^{-3} \leq \text{the_capacity_of_AC_motor_drive(kVA)}$$

- The current should be less than the rated current of AC motor drive(A)

$$k \times I_M \leq \text{the_rated_current_of_AC_motor_drive(A)}$$

Symbol explanation

P_M : Motor shaft output for load (kW)

η : Motor efficiency (normally, approx. 0.85)

$\cos \varphi$: Motor power factor (normally, approx. 0.75)

V_M : Motor rated voltage(V)

I_M : Motor rated current(A), for commercial power

k : Correction factor calculated from current distortion factor (1.05 - 1.1, depending on PWM method)

P_{c1} : Continuous motor capacity (kVA)

k_S : Starting current/rated current of motor

n_T : Number of motors in parallel

n_S : Number of simultaneously started motors

GD^2 : Total inertia (GD^2) calculated back to motor shaft (kg m^2)

T_L : Load torque

t_A : Motor acceleration time

N : Motor speed

B-2 General Precautions

Drives Selection

1. When the AC Motor Drive is connected directly to a large-capacity power transformer (600kVA or above) or when a phase lead capacitor is switched, excess peak currents may occur in the power input circuit and the converter section may be damaged. To avoid this, use an AC input reactor (optional) before AC Motor Drive mains input to reduce the current and improve the input power efficiency.
2. When a special motor is used or more than one motor is driven in parallel with a single AC Motor Drive, select the AC Motor Drive current $\geq 1.25 \times$ (Sum of the motor rated currents).
3. The starting and accel. /decel. characteristics of a motor are limited by the rated current and the overload protection of the AC Motor Drive. Compared to running the motor D.O.L. (Direct On-Line), a lower starting torque output with AC Motor Drive can be expected. If higher starting torque is required (such as for elevators, mixers, tooling machines, etc.) use an AC Motor Drive of higher capacity or increase the capacities for both the motor and the AC Motor Drive.
4. When an error occurs on the drive, a protective circuit will be activated and the AC Motor Drive output is turned off. Then the motor will coast to stop. For an emergency stop, an external mechanical brake is needed to quickly stop the motor.

Parameter Settings

1. The AC Motor Drive can be driven at an output frequency up to 400Hz (less for some models) with the digital keypad. Setting errors may create a dangerous situation. For safety, the use of the upper limit frequency function is strongly recommended.
2. High DC brake operating voltages and long operation time (at low frequencies) may cause overheating of the motor. In that case, forced external motor cooling is recommended.
3. Motor accel./decel. time is determined by motor rated torque, load torque, and load inertia.
4. If the stall prevention function is activated, the accel./decel. time is automatically extended to a length that the AC Motor Drive can handle. If the motor needs to decelerate within a certain time with high load inertia that can't be handled by the AC Motor Drive in the required time, either use an external brake resistor and/or brake unit, depending on the model, (to shorten deceleration time only) or increase the capacity for both the motor and the AC Motor Drive.

B-3 How to Choose a Suitable Motor

Standard motor

When using the AC Motor Drive to operate a standard 3-phase induction motor, take the following precautions:

1. The energy loss is greater than for an inverter duty motor.
2. Avoid running motor at low speed for a long time. Under this condition, the motor temperature may rise above the motor rating due to limited airflow produced by the motor's fan. Consider external forced motor cooling.
3. When the standard motor operates at low speed for long time, the output load must be decreased.
4. The load tolerance of a standard motor is as follows:

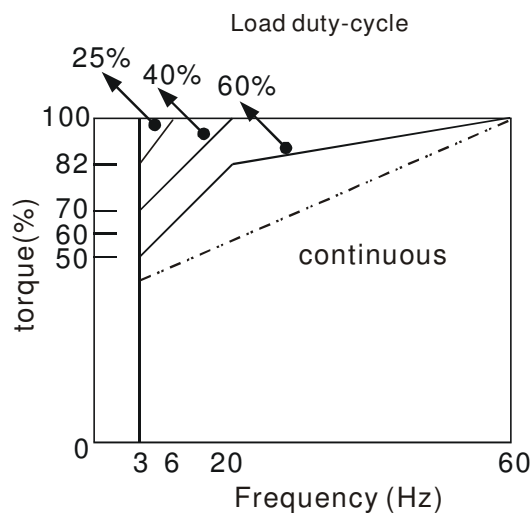

5. If 100% continuous torque is required at low speed, it may be necessary to use a special inverter duty motor.
6. Motor dynamic balance and rotor endurance should be considered once the operating speed exceeds the rated speed (60Hz) of a standard motor.
7. Motor torque characteristics vary when an AC Motor Drive instead of commercial power supply drives the motor. Check the load torque characteristics of the machine to be connected.
8. Because of the high carrier frequency PWM control of the VFD series, pay attention to the following motor vibration problems:
 - Resonant mechanical vibration: anti-vibration (damping) rubbers should be used to mount equipment that runs at varying speed.
 - Motor imbalance: special care is required for operation at 50 or 60 Hz and higher frequency.
 - To avoid resonances, use the Skip frequencies.
9. The motor fan will be very noisy when the motor speed exceeds 50 or 60Hz.

Special motors:

1. Pole-changing (Dahlander) motor:

The rated current is differs from that of a standard motor. Please check before operation and select the capacity of the AC motor drive carefully. When changing the pole number the motor needs to be stopped first. If over current occurs during operation or regenerative voltage is too high, please let the motor free run to stop (coast).

2. Submersible motor:

The rated current is higher than that of a standard motor. Please check before operation and choose the capacity of the AC motor drive carefully. With long motor cable between AC motor drive and motor, available motor torque is reduced.

3. Explosion-proof (Ex) motor:

Needs to be installed in a safe place and the wiring should comply with the (Ex) requirements. Delta AC Motor Drives are not suitable for (Ex) areas with special precautions.

4. Gear reduction motor:

The lubricating method of reduction gearbox and speed range for continuous operation will be different and depending on brand. The lubricating function for operating long time at low speed and for high-speed operation needs to be considered carefully.

5. Synchronous motor:

The rated current and starting current are higher than for standard motors. Please check before operation and choose the capacity of the AC motor drive carefully. When the AC motor drive operates more than one motor, please pay attention to starting and changing the motor.

Power Transmission Mechanism

Pay attention to reduced lubrication when operating gear reduction motors, gearboxes, belts and chains, etc. over longer periods at low speeds. At high speeds of 50/60Hz and above, lifetime reducing noises and vibrations may occur.

Motor torque

The torque characteristics of a motor operated by an AC motor drive and commercial mains power are different.

Below you'll find the torque-speed characteristics of a standard motor (4-pole, 15kW):

AC motor drive

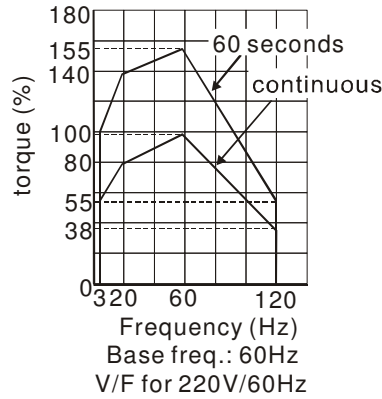

Motor

